

TERRAINE

ARCHITECTURAL +
LANDSCAPE
PATTERN BOOK



APRIL 2024



TERRAINE

ARCHITECTURAL +
LANDSCAPE
PATTERN BOOK



APRIL 2024

CONTENTS

PREFACE 1

1.0

THE VISION FOR TERRAINE. 3

1.1 GUIDING VALUES. 5

1.2 THE TERRAINE PLAN – THE EVOLUTION OF A SMALL WESTERN TOWN 7

1.3 TERRAINE DESIGN THEMES 8

1.4 THE TERRAINE COMMITMENT TO SUSTAINABLE DESIGN 10

1.5 THE TERRAINE DESIGN STYLES – CONTEXT & APPROACH 10

2.0

SITE AND LANDSCAPE GUIDELINES 13

SMALL TOWN PATTERNS & CRITERIA

2.1 SITE, PLANNING AND LANDSCAPE OBJECTIVES. 14

2.2 HOMESITE TYPES 15

2.3 HOMESITE PATTERNS AND SETBACK CRITERIA 15

2.4 GRADING AND DRAINAGE 16

2.5 RETAINING WALL DESIGN 17

2.6 EXTERIOR STAIRS 18

2.7 DRIVEWAYS, GARAGES AND EXTERIOR PAVING 19

2.8 PARKING REQUIREMENTS. 19

2.9 OUTDOOR ROOMS – PATHS, COURTYARDS & TERRACES 20

2.10 PLANTING DESIGN – REINFORCING THE PRAIRIE GRASSLAND LANDSCAPE. 21

2.11 IRRIGATION. 24

2.12 LANDSCAPE EDGES: FENCES, WALLS, SHRUB SCREENS & GATES. 24

2.13 LANDSCAPE STRUCTURES & SITE FURNISHINGS 28

2.14 WATER FEATURES – POOLS & FOUNTAINS. 28

2.15 EXTERIOR LIGHTING. 30

2.16 ADDRESS MARKERS 30

2.17 UTILITIES & SERVICE AREAS. 31

3.0

ARCHITECTURAL GUIDELINES	33
3.1 ESTABLISHING THE ARCHITECTURAL FABRIC	34
THE ARCHITECTURAL DESIGN OBJECTIVES OF TERRAINE	
3.2 GENERAL ARCHITECTURAL GUIDELINES	35
3.2.1 Building Height	35
3.2.2 Chimneys & Roof Projections	35
3.2.3 Outbuildings – Garages and/or Ancillary Structures	35
3.2.4 Colors & Finishes	36
3.2.5 Building Materials Selection	36
3.2.6 Mechanical Systems	37
3.2.7 Skylights & Satellite Dishes	37
3.2.8 Solar Equipment	37
3.3 THE TERRAINE HOME	38
ARCHITECTURAL STYLES FOR A SMALL WESTERN TOWN	
3.3.1 Craftsman	39
3.3.2 Mining	45
3.3.3 Farmhouse	51
3.3.4 Prairie	57

4.0

DESIGN REVIEW PROCESS	63
4.1 PROJECT TYPES TO BE REVIEWED.	64
4.2 DESIGN REVIEW PROCESS OVERVIEW	64
4.3 DESIGN REVIEW PROCESS – MINOR IMPROVEMENTS	65
4.4 ACTIONS AND APPROVALS	65
4.5 DESIGN PROFESSIONALS	65
4.6 INITIAL CONFERENCE	66
4.7 SCHEMATIC DESIGN REVIEW	66
4.8 DESIGN DEVELOPMENT REVIEW	68
4.9 CITY OF WEST JORDAN APPROVAL.	69
4.10 CONSTRUCTION DOCUMENTS. PREPARATION	70
4.11 SUBSEQUENT CHANGES	70
4.12 CONSTRUCTION REVIEW OBSERVATIONS.	70
4.13 NOTICE TO COMPLY	70
4.14 COMPLIANCE CERTIFICATE	70
4.15 RIGHT OF WAIVER	70
4.16 NON-WAIVER, INADVERTENT PRECEDENTS	71
4.17 DESIGN REVIEW SCHEDULE	71
4.18 APPLICATION FEES	71
APPENDIX A: DEFINED TERMS	72
APPENDIX B: APPROVED PLANT LIST & SEASONAL CHARTS.	74
APPENDIX C: DESIGN DOCUMENTS	79



P R E F A C E

The Terraine Architectural and Landscape Pattern Book establishes the architectural traditions, aesthetic guidelines and sustainability approaches established for all new buildings and associated Improvements, building additions, site work and landscaping at Terraine. These Guidelines also address the design review process and the Terraine Design Review Committee (DRC) approval, for the same types of Improvements. The Appendices contain a glossary of defined terms (capitalized in document) used throughout the Guidelines, an Approved Plant List and a list of design documents. The Guidelines are intended to ensure all building and landscape designs are compatible with the site, the overall environment and the design

objectives at Terraine. These Guidelines are to be used in conjunction with any subsequent Neighborhood Pattern books as applicable.

The Guidelines will be administered and enforced by the DRC in accordance with procedures set forth in the Master Declaration of Covenants, Conditions, and Restrictions for Terraine (Master Declaration). In the event of any conflict between the Guidelines and the Master Declaration, the Master Declaration shall govern and control. In addition to the Guidelines and Master Declaration, all building and site Improvements are to comply with applicable sections of the design documents for Terraine (see Appendix C) and local, state and federal requirements.

The Guidelines may also be amended from time to time by the DRC. It is the Homebuilder's, Owner's or Contractor's responsibility to ensure they have the most current edition of these Guidelines and any applicable Neighborhood Guidelines, and have carefully reviewed all applicable sections of the Master Declaration. The illustrations and images in this document are intended to convey a concept, and not to portray specific plans for construction. These Guidelines are binding on any persons, company or firm that intends to construct, reconstruct, or modify any permanent or temporary Improvements within Terraine. Owners and their consultants and contractors should familiarize themselves with these rules prior to start of design or construction.



TERRAINE PATTERN BOOK

1.0

THE VISION FOR
TERRAINE

The Plan for Terraine is built upon the fundamental concepts of conservation, balance and community. The Plan enables a rural settlement pattern that honors the pioneering legacy of the land and the wide open, western grassland landscape of the Salt Lake Basin.

Terraine's guiding goal is to establish a small town, rural framework that creates a community based on healthy living and comfort while staying flexible and embracing change and evolution. Six core values guide and inspire the design and implementation of the Plan for Terraine:



1.1 GUIDING VALUES

01

FORWARD-LOOKING

Look ahead rather than to the past. Explore fresh, resource-smart and inventive ways to establish a 21st century community while respecting the site's legacy.

04

SIMPLICITY AND INTEGRITY

These values are applied to every level of planning, design and the creation of "community". Choosing materials, fashioning construction techniques, devising building programs and/or thinking through sustainable approaches -- these values are the starting point. The results are an imperfect, rustic, rural aesthetic that is both contemporary and rooted to the land and its mining and ranching legacy.

02

BALANCE

Use nature as a guide. The idea is to build and improve the land to complement rather than dominate the grassland setting. This approach then honors the natural functions of the site, or better yet, functioning at a higher level.

05

CRAFTSMANSHIP

Support and enable the values of craftsmanship. This approach emphasizes thoughtful, durable and high-quality community design concepts. The focus on quality enables integrated and responsive design solutions.

03

RESILIENCY

Create a community that is flexible, self-reliant and resourceful. This results in a dynamic equilibrium – a constantly evolving and healthy environment that encourages innovative solutions, restorative practices and sustainable approaches.

06

CONNECTED

Create a community that is connected to the region, this place, its history, and its natural systems through regional design concepts, and contextual landscape and architectural approaches. Each neighborhood is planned to have a variety of home types as well as architectural styles connected to the legacy of the land. This sets the foundation to firmly establish and attract a diverse, inclusive community of people that value and participate in the long-term stewardship of the land and the community's balanced growth.



View of neighborhood trail -- creating a comfortable, human-scaled small town within the great basin sagebrush ecosystem.

1.2 THE TERRAINE PLAN: THE EVOLUTION OF A SMALL WESTERN TOWN

The main components of Terraine's setting and community are based on the core principle of creating a comfortable, human-scaled, and walkable small-town over time. The main organizational approach of the Community Plan sets the neighborhoods within the low-lying valley areas, while preserving the higher foothill areas to create a vast open space network that both surrounds and is interwoven throughout the Community.

NATURAL FOOTHILLS AND HILLTOPS

The Foothills surround the overall community to the west and provide a vast open space grassland landscape and habitat zone that characterizes the rolling topography at the base of the Oquirrh Mountains. Several prominent internal hilltops provide a further backdrop for the neighborhoods in Terraine. In total these public open spaces comprise over 160 acres, and weave through and are connected by an internal park system to the neighborhoods and provide a diversity of recreational and cultural amenities, including an extensive trail system and seasonal outdoor play facilities.

THE COMMONS AND CENTRAL VILLAGE

At the heart of Terraine is a traditional small-town center which includes a central meadow and "Commons" --the gathering place for the community which serves as multi-functional space for events, meetings, and recreation. The Commons area buildings are inspired by the simple American western architectural traditions of the Farmhouse and Mining styles. The building program includes indoor meeting, event and gathering areas, a community bistro and generous outdoor landscaped areas, including a small amphitheater. Nestled around the Commons area is a diversity of village home and commercial types that are connected up by the extensive trail and street network.

WESTERN HILLS

Nestled between the internal Hilltops and the Western Foothills, these neighborhoods provide a range of larger homes including many that will front on the perimeter trail through the natural open space interlinked to the Hilltops, Central Village and open space areas.

CENTRAL RIDGE AND NORTH VILLAGE AREAS

The Central Ridge is a prominent feature separating the Central Village and the North Areas. The Central Ridge is home to some of the most expansive view Homesites in the Community that orient to a perimeter open space trail. The North Village Area will have a similar feel to the Central Village, including its own Village Center and dramatic backdrop of the Western Foothills.

LINKAGES

All neighborhoods and open space areas are linked up by an extensive open space and trails system as well as a layered system of streets and alleys that reflect a walkable, small town settlement pattern.

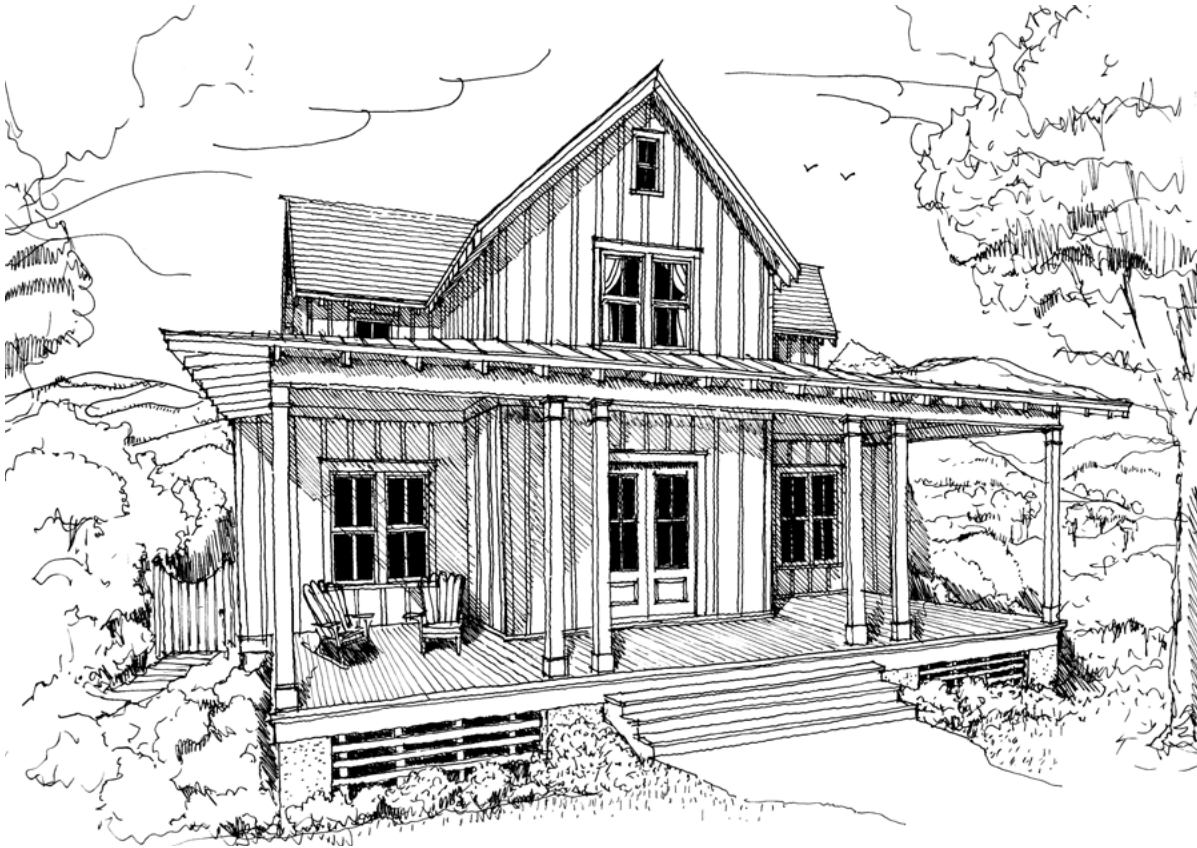

1.3 TERRAINE DESIGN THEMES

The design themes outlined below are the common threads that run through the design of individual buildings, landscapes, streetscapes, community areas and trail networks. Owners, Contractors and design teams are to work together from the initial phases of design to ensure all aspects of the design are consistent with these design themes:

- **Celebrate and build on the local context:** The rural mining and ranching towns of Utah used the fundamental concepts of cluster development to grow over time into truly memorable places. Building designs are to draw from the mining and ranching legacies to create a place that is connected to this history. This means simple, unadorned building forms and human-scaled proportions to create a contemporary built environment that is comfortable, rich and inviting.
- **Maintain a Human Scale of Architecture:** Buildings are to be personal and intimate in scale. Main building masses are to be surrounded by simple wings and elements that express a size and scale consistent with the functions they enclose. Additive elements such as porches, bay windows, dormers, balconies and doorways contribute a rich and varied architecture while enhancing the streetscape.
- **Express Care and Craftsmanship in Detailing:** Diversity of design and individual expression are encouraged provided the collective result creates a visually harmonious community. Custom detailing at exterior walls, porches, and/or building projections provides opportunities for individual expression and gives buildings their own unique “personality”.

- Take Advantage of Climatic Influences:** The climate in West Jordan area exhibits a dynamic pattern of changing conditions throughout the year. Buildings and outdoor spaces are to be designed with this in mind. Roofs may provide welcome shade at porches during the summer and a protected entryway during winter snowfalls. Outdoor rooms are to be designed with their potential use and weather constraints in mind.
- Contribute to Creating an Attractive Streetscape:** Building frontages are to avoid a “suburban” pattern of repetitive driveways and garages. Careful site planning, landscaping and massing design are to complement the neighborhood streetscape as well as individual buildings.
- Foster Community Interaction:** Buildings are to be designed with a strong sense of connection to the outdoors. The close relationship with the outdoors fosters interaction among neighbors. In addition to outdoor rooms located in more private and intimate areas of the home, porches, terraces and other outdoor living areas may be oriented towards streets to enhance community interaction. These semi-private places extend the livability of the home while allowing informal interaction with the neighborhood.
- Encourage the design of resilient building systems and site development approaches:** Terrain is envisioned as a sequence of dynamic, small-town neighborhoods, that are anchored by a dominant open space framework and preservation ethic. Within this framework, it is encouraged that designs explore advanced technologies and approaches in living sustainably on the land while ensuring that improvements are consistent with the values and objectives outlined in these Guidelines.



The Terraine Community Plan

1.4 THE TERRAINE COMMITMENT TO SUSTAINABLE DESIGN

Terraine encourages sustainable building concepts in the planning and development of all Improvements within the Community. Sustainable design is a philosophy that includes all aspects of site planning, building programming and design, and construction to minimize the impacts on economic, cultural, and environmental resources. At Terraine this means creating complete environments that utilize proven building approaches of the past combined with the best new technological advances to enhance human health, efficient use of water, energy and other resources as well as protection of natural habitats.

Sustainable ecological principles play a major role in the design of Terraine. These principles are emphasized through the use of native, drought tolerant plant palettes, the creation and preservation of grassland habitat and movement corridors, stormwater capture and treatment, and infiltration and shading to reduce heat islands throughout the community. The comprehensive open space system aims to protect and enhance the grassland landscape while providing passive and active use to the Community. The Terraine Community Plan reinforces the ecological and visual connection to the Oquirrh Mountains by retaining essential view and drainage corridors. Energy conservation will be enhanced via passive and active building design and the required utilization of the HERS rating system when designing all new homes.

1.5 THE TERRAINE DESIGN STYLES – CONTEXT AND APPROACH

Terraine draws upon the architectural and landscape traditions that shaped the Salt Lake Basin and regional western mountain towns. The goal is the creation of a sequence of neighborhoods composed of a variety of architectural styles with a consistent quality of character and detail knitted together by a comprehensive, integrated landscape treatment.

At Terraine, the intent is to build on the Craftsman, Mining, Farmhouse and Prairie architectural traditions while developing contemporary interpretations and details that incorporate sustainable concepts. The Architectural Guidelines illustrate and describe the key elements and design strategies of the architectural traditions that helped to shape the region's most enduring neighborhoods.

The landscape concepts are based on the Great Basin Sagebrush Ecosystem that takes its cues from the surrounding grassland setting and ranching traditions to create informal landscape treatments and structures with minimal formal design elements except in private areas. The Site and Landscape Guidelines illustrate and describe the key planting approaches, palettes and site improvements that help to characterize this tradition.



View of Commons Area looking west to the community bistro and western hills.



TERRAINE PATTERN BOOK

2.0

SITE & LANDSCAPE GUIDELINES – SMALL TOWN PATTERNS & CRITERIA

The landscape concept for Terraine focuses on building on the Great Basin Sagebrush landscape to knit together a series of pedestrian-scaled environments set amongst the valleys at the base of the Oquirrh mountains. Residential scale buildings and associated outdoor areas are to connect to the larger public spaces (streets, paths, greens, alleys) to create a diverse network

of public and private “outdoor rooms”. The sagelands landscape is the “form giver” and is to be enhanced and reinforced to create a comprehensive landscape that weaves through and around the Community.

The following sections set forth Guidelines and standards for all residential site and landscape improvements at Terraine.

2.1 SITE, PLANNING AND LANDSCAPE OBJECTIVES

Three principles drive the site design, planning and landscape approach at Terraine:



Create landscape and site designs that respond to the unique attributes of the Homesite while reinforcing the overall community landscape.

The characteristics of each Homesite (i.e. sun orientation, light penetration, prevailing breezes, Homesite size and position on the block) shape the layout, building program, massing, organization of indoor and outdoor rooms and the transition from the public realm to the private realm. This ensures that there will be a diversity of solutions and that a varied community pattern evolves.



Design “outdoor rooms” to be extensions of indoor areas and the overall community landscape. Residential landscapes are to be thought of as a series of private outdoor spaces that provide the gradual transition to public zones (trails, streets, alleys, sidewalks). These rooms should unfold slowly to the viewer in order to build an atmosphere of discovery and spontaneity. This can be established by combining built elements (fences, walls, trellis, terraces, exterior stairs, building projections) with informal shrubs, vines, and trees to create layers of edges and defined spaces.



Use natural materials, regional paving patterns, details and plant materials that draw from the rural ranching traditions. Utilizing regional materials and vernacular to create contemporary environments reinforces the creation of an “authentic” place.

2.2 HOMESITE TYPES

In order to create a varied and rich streetscape, the Terraine Community Plan (“Community Plan”) and Homesite Matrix (“Matrix”) identifies a set of development standards and setback criteria for each Homesite consistent with the City of West Jordan’s governing documents (refer to Appendix C). The Community Plan is to be used in concert with these Guidelines, the Homesite Matrix and governing documents for the design and construction of all built Improvements on a Homesite.

There are five single family and three multi-family Homesite Types, each is defined by its minimum lot size, frontage and other unique attributes. Refer to the Community Plan and Homesite Matrix for specific development standards and setback criteria for each Homesite:

SINGLE FAMILY HOMESITES

Wide Lots:

Those Homesites that have a minimum interior Lot Area of 6,750 feet and minimum frontage of 75’ and 90’ minimum depth.

Medium Lots:

Those Homesites that have a minimum interior Lot Area of 4,500 feet and minimum frontage of 50’ and 90’ minimum depth.

Narrow Lots:

Those Homesites that have a minimum interior Lot Area of 2,625 feet and minimum frontage of 35’ and 75’ minimum depth.

Green Court Lots:

Those Homesites that have a minimum interior Lot Area of 6,750 feet and minimum frontage of 30’ and 50’ minimum depth.

Flag Lots:

Those Homesites that have a minimum interior Lot Area of 1,500 feet and minimum frontage of 30’ and 50’ depth.

MULTI FAMILY UNITS/LOTS

Townhome Unit:

Those Units that have a minimum interior Lot Area of 1,100 feet and minimum frontage of 22’ and 50’ minimum depth.

Tuck Under Lot:

Those Lots that have a minimum interior Lot Area of 6,000 feet and minimum frontage of 60’ and 100’ minimum depth.

Podium Building Lot:

Those buildings that have a minimum interior Lot Area of 10,000 feet and minimum frontage of 100’ and 100’ minimum depth.

2.3 HOMESITE PATTERNS AND SETBACK CRITERIA

Each Homesite within the Terraine has been planned to ensure buildings and related Improvements are sited to optimize the relationship of the individual home to the overall streetscape and adjacent homes. In addition, Homesite Types have been designed to provide a diversity of homes in each neighborhood.

Building frontage on Terraine streets is to vary along each street. Factors influencing building setbacks may include desired proximity to the street/right of way, potential impact on adjacent trails, privacy to/from neighboring Homesites and/or visibility from public view sheds and to the Hilltop open spaces. In order to create varied streetscapes, each neighborhood within Terraine may have a “Neighborhood Book” in addition to this Master Guideline that sets out more specific design criteria.

Owners and their Consultants are to refer to the Community Plan, Homesite Matrix and Neighborhood Book (as applicable) when siting buildings and other Improvements on their Homesite for applicable development standard criteria. Minimum setbacks are established in the PCH Zone, and in some cases these Guidelines define further setback requirements.

2.4 GRADING AND DRAINAGE

Grading and drainage Improvements are to focus on minimizing impact to the site, protecting water quality, and promoting the use of natural drainage systems.

The Design Review Committee requires that a Civil Engineer or Landscape Architect registered in the State of Utah prepare a full set of drawings including grading, drainage, utility locations, and revegetation plans for new construction. All drainage and grading Improvements are to comply with the Master Grading and Drainage Plans for Terraine available from the Design Review Committee.

The following standards are to be met in all drainage and grading plans within the Terraine:

GRADING

- Grading designs are to generally utilize natural and/or curvilinear shapes that blend into the natural landscape to the extent feasible, rather than straight and angular solutions.
- Cut and fill slopes are to be revegetated and blended into the surrounding environment.
- Retaining walls may be used to minimize site disturbance, refer to Section 2.5 for Retaining Wall Design.



Grading and drainage Improvements are to focus on minimizing disruption of the site

DRAINAGE

- Stormwater collection is to work with natural drainage systems to the greatest extent possible. Natural swales and native vegetation cover are to be used to absorb and filter runoff and promote infiltration while directing water to the community drainage system. Impervious surfaces are to be minimized to the fullest extent feasible to encourage water percolation into the ground. The use of more pervious (water permeable) materials, such as compacted crushed rock, or open-celled pavers are encouraged. (See Section 2.7 for appropriate paving materials).
- Measures should be taken to prevent water damage to house foundations such as sloping grades away from the house at a minimum of ½ inch to the foot, proper compaction of backfills and/or damp proofing foundations.
- Gutters and downspouts are to direct drainage away from foundations and paved surfaces into natural drainage systems such as crushed rock beds or swales. Gutters and/or downspouts are not to direct drainage onto adjacent Lots, (unless into a defined drainage easement), or sidewalks.
- Grass, mulch or gravel is to be placed under the dripline of non-guttered roofs to prevent soil erosion and to increase ground absorption.

2.5 RETAINING WALL DESIGN

Retaining walls are to be used when it is necessary to minimize disturbance or where they are designed as extensions of the architecture. Retaining walls are to be a maximum of 4 feet in height and utilize more rustic material applications that complement the rural vernacular such as stacked stone, gabion systems or heavy timbers.

- Terraced wall structures with ample planting pockets (minimum 4 feet wide) are to be used where grade changes exceed 4 feet.
- Retaining walls up to 6 feet in height may be considered on a case-by-case basis.
- Shrubs, grasses and/or vines are to be planted at the base and top of retaining walls to blend them with the site.

Approved materials for retaining walls include:

- » Stacked stone
- » Board formed concrete
- » Gabion treatments
- » Weathered brick, cobble or unit pavers, informally stacked,
- » Stucco applications, light sand finish, and
- » Heavy timber applications.

Non-permitted materials for retaining walls or systems include:

- » Uncolored concrete applications
- » Stucco with smooth finish
- » Brick with smooth, machined finish
- » Rip-rap applications, including boulder treatments

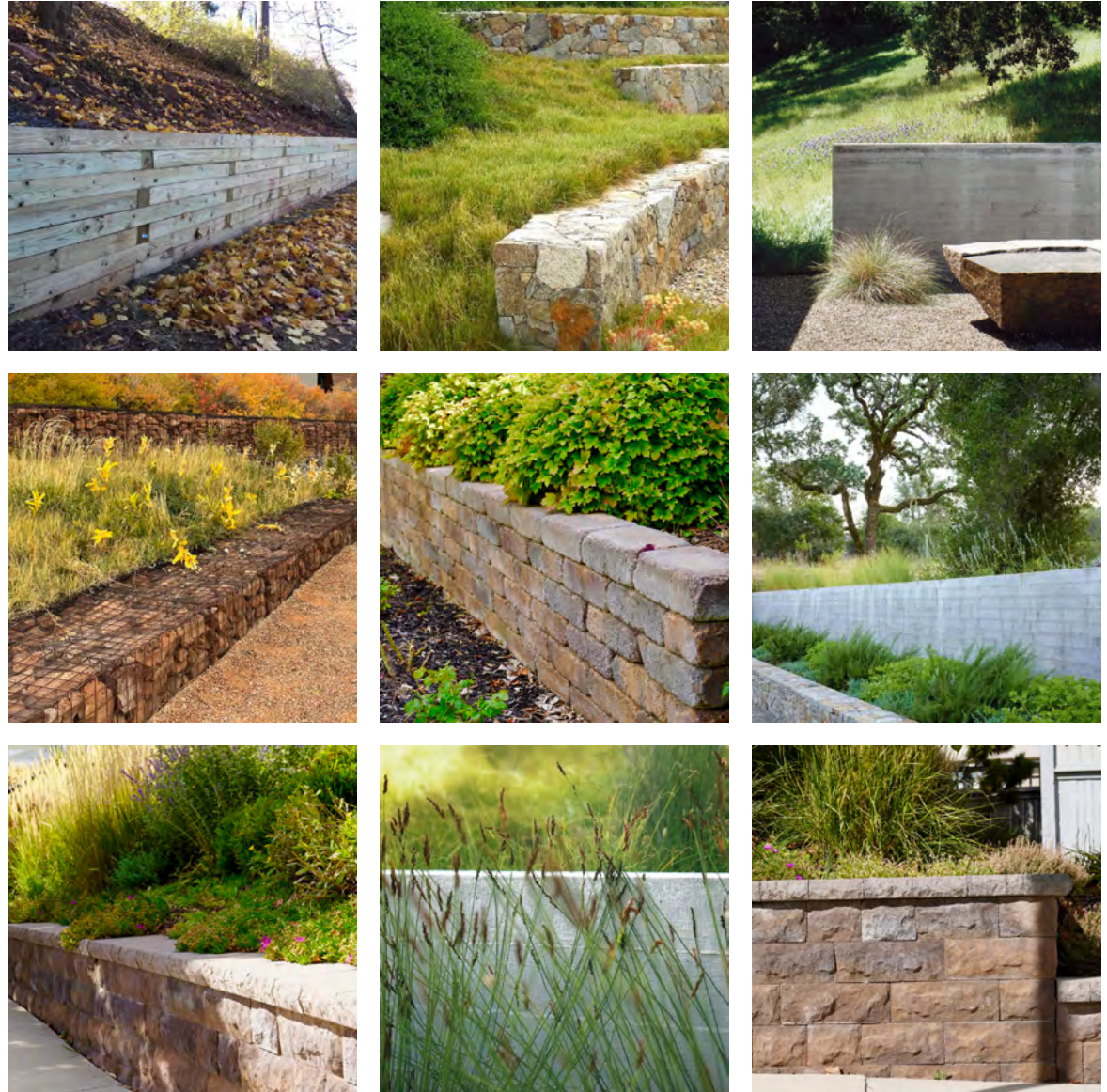

Figure 2.1 - Terrain Retaining Wall Treatments

2.6 EXTERIOR STAIRS

Exterior stairs are critical for transitioning between public and private realms to create an entry into the home from the street. The main goal is to create a sequence of where the stairs and the home create a unified composition. The design of this sequence provides opportunities for unique design solutions which adds richness and character to the streetscape and the home.

PORCH STAIRS

Stairs that directly access the porch should generally align with the front door of the home. Porch stairs should be a minimum of six feet wide and consistent with the applicable Architectural Style.

SITE STAIRS

Depending on the location of the entry of the Homesite and slope condition, designing the site stairs is critical in creating a gradual, comfortable transition to the private area of the porch while blending stairs into the landscape. Minimum widths of site stairs is 5 feet, and are to be integral colored concrete or similar consistent with the DRC's approved materials and colors palette. Cheek walls are to be used for all site stairs in order to blend them into the landscape and minimize erosion.



Exterior stair design is to create a gradual and comfortable transition from the public to private realms

2.7 DRIVEWAYS, GARAGES AND EXTERIOR PAVING

Driveways, garage aprons and garage doors are to be designed to minimize their visibility from streets and alleys and the principal rooms, porches, decks or terraces of adjoining homes and to blend into the landscape through careful siting, design, use of architectural devices and plant materials. Driveways are to be subordinate to the Homesite's landscape and architecture.

Approved driveway paving materials include:

Pervious:

- » *Compacted crushed rock or fines*
- » *Open-celled pavers*
- » *Granite, cobblestone, and/or native stone (sand set)*

Impervious:

- » *Unit/pre-cast pavers*
- » *Tumbled Brick*
- » *Integral colored concrete, banded with stone and/or seeded*
- » *Granite, cobblestone, and/or stone (mortared)*

Inappropriate driveway paving materials include:

Paving

- » *Modern brick with sharp, machined edges*
- » *Untextured, uncolored concrete*
- » *Bomanite*

Edging

- » *Concrete block*
- » *Boulders*
- » *Low wire fencing*

- Pervious materials (water permeable) are to be used to the greatest extent possible to maximize water infiltration.
- Driveways may only enter the garage as shown on the Community Plan unless unforeseen site conditions exist that would justify an alternate driveway alignment and/or access.
- Driveways are to be a maximum of 16-20 feet wide except at the driveway apron to garage entrances.



Driveway door design

2.8 PARKING REQUIREMENTS

Each Homesite is to contain a minimum of two parking spaces or as specified in governing documents for Terraine. Guest parking may occur on streets, driveways, alley areas and/or driveway apron areas.

2.9 OUTDOOR ROOMS – PATHS, COURTYARDS AND TERRACES

Paths, outdoor terraces and courtyards are to be combined with plant materials, fencing, walls and architectural devices such as balconies, verandas, and trellises to create outdoor garden “rooms”. Brick, granite or cobblestone (impervious materials) may be used in areas immediate to Buildings. Moving away from the house there is to be a gradual transition to pervious or “softer” surfaces such as crushed rock or open celled pavers. Refer to Section 2.7 for approved paving materials.

- Paved areas are to minimize the number of different types of paving materials in order to produce an understated, unified design.
- Vines, shrubs and ground covers are to be planted on and adjacent to outdoor stairways, paths, building projections and terraces to reinforce the landscape and its integration with the architecture.
- Impervious surface areas are to be minimized to the extent possible and pervious materials used instead to maximize water infiltration.
- Paved and/or improved surfaces are not to occur within 2 feet of any property line, with the exception of front entry stairs, side yard walks and driveways.

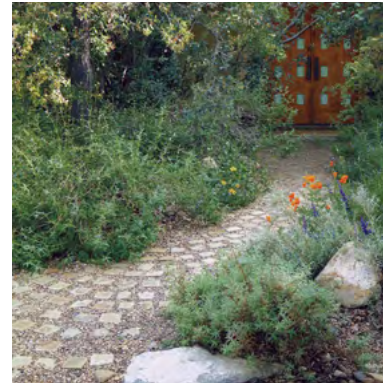

Terraine paving treatments are to be more rustic in character

2.10 PLANTING DESIGN – REINFORCING THE GREAT BASIN SAGEBRUSH LANDSCAPE

Planting design emphasizes strengthening the links between indoor and outdoor rooms as well as contributing to the larger community landscapes and streetscapes. Landscape designs are to extend this principle to the outside by providing a gradual transition from the public community spaces (streets, alleys, sidewalks and trails) to the more private outdoor and indoor spaces.

General landscape and planting guidelines include the following:

- Refer to Appendix B for approved Plant Palettes that include a combination of indigenous as well as naturalized or historically significant plant species. These plants are adapted to the climate, are less invasive, require less water and less maintenance. Plants not included on the Approved Plant List in Appendix B may be used, with Design Review Committee approval, provided they are suited to the natural setting and design concept, require less water and are not invasive.
- The open space system within the Terraine is to be extended and enhanced to the extent feasible on each Homesite so that all Improvements are woven into the larger community landscape and streetscape.
- Landscape is to be pervasive and intertwined/combined with built elements wherever possible. Plantings are to spill over onto surrounding site walls, paving, steps and fences to blend the built environment with the natural grassland setting. Vines may be used to fill between structural components of walls and/or stairs.
- Fences and/or site walls are to be planted with low informal shrubs, ground covers and/or grasses and intertwined with vines to establish an informal landscape “edge”.
- Shrubs may be planted informally to create outdoor spaces, give definition to the street (rather than a fence) and/or to screen service and/or driveways.
- Plantings, particularly along house foundations, are to appear “untamed” and loose rather than formal, aligned patterns.
- “Next generation” canopy trees (deciduous or evergreen) are to be included in landscape designs to create shade (in particular on south and southwest exposures) and shadow, and to contribute to the Terraine urban forest. Refer to the Approved Plant List for a full range of suitable trees.
- On those Homesites where driveway access is from the street, planting materials should be placed to obscure views of the garage and driveway to the extent feasible.
- Plant materials may be used to create a green “living” fence. See Section 2.12 – Landscape Edges: Fences, Walls, Shrub Screens, and/or Gates as well as the Approved Plant Palette for suitable informal screen shrubs.

PLANTING REQUIREMENTS

Planting designs within Terraine are to extend and continue the Community’s sagelands framework. An integrated planting concept is to include canopy trees, understory trees, shrubs and grasses to create a variety of levels in the landscape. In order to meet this objective, the following planting requirements have been established:

Canopy Trees

- Each Homesite over 2,500 Square feet is to be planted with at least one large canopy tree (2 inch minimum caliper size).
- Canopy trees are to be planted in natural patterns. In order to assure canopy trees flourish and thrive, they are to be planted per their recommended spacing.
- The Design Review Committee may require additional canopy trees and/or larger sizes, as necessary, to adequately filter views from streets, public spaces and/or open space areas.

Understory Trees

- In addition to canopy trees, each Homesite is to be planted with one understory tree for every 2,500 square feet of the Homesite, rounded to the nearest whole number.
- Proposed understory trees are to be a minimum caliper size of 2 inches.
- Spacing and planting patterns for understory trees is to supplement and complement canopy tree and/or streetscape planting patterns.
- Refer to the Approved Plant List in Appendix B for suitable understory tree plantings.
- The Design Review Committee may require additional understory tree plantings, as necessary, to adequately filter views from streets, public spaces and/or to the trail network.
- Owners may plant additional trees, as desired, from the approved plant list provided in Appendix B.

Shrubs/Vines/Grasses

- An integrated planting design that includes shrubs, vines and/or grasses is required along all foundations, garages or similar exterior foundations to anchor buildings to the landscape.
- Plantings are required in alleys and lanes to create comfortable outdoor, landscaped “rooms”. Shrubs may be used to surround alleys, vines may be used to create vertical “green” walls and grasses are to be used to soften paved areas and fencing.



Planting design is to borrow from the Great Basin Prairie landscape tradition

2.11 IRRIGATION

To aid in water conservation, planting design is to reduce water consumption while using minimal and efficient irrigation systems.

- Utilizing indigenous or naturalized plant materials, grouped according to water consumption needs, is required to reduce water needs and to extend the natural ecosystems and habitat of Terraine. Refer to the Approved Plant Lists in Appendix B.
- All permanent irrigation systems are to be below ground and fully automatic. Use of water conserving systems is required such as drip irrigation and moisture sensors. An electric, solid state controller is required for all systems and shall be equipped with a master valve terminal and at least two fully independent programs.
- Rain/moisture sensors that shut off irrigation during or after rainfall are to be installed.
- The use of mulch at least four (4) inches deep in planting areas is encouraged to retain moisture and reduce erosion.
- Temporary irrigation systems are required at all revegetation areas. These systems may be abandoned when plantings have been clearly established after a minimum of one growing season.
- Limit turf areas on Homesites that require a lot of supplemental watering to a functional scale, with a minimum dimension of 6-10 feet, not to exceed 50% of the landscaped area of a homesite. If turf is used, selecting drought tolerant and/or no mow turf types is encouraged.

2.12 LANDSCAPE EDGES: FENCES, WALLS, SHRUB SCREENS AND GATES

In general, fencing is to be minimized and landscape treatments used in lieu of fencing. Fences, walls, shrub screens and gates are to extend the architecture of the residence, give definition and variety to the streetscape and outdoor spaces, and screen service areas. Designs are to draw from the rural western ranch traditions which are generally more informal, rustic and textural.

- All fences and walls are to be combined with informal shrubs, grasses and/or vine plantings.
- Fence and wall designs are to utilize a Terraine approved fence/wall type, available from the DRC.
- Fencing solutions are to be used to block views of utilities, mechanical units, trash enclosures and outdoor work areas.
- Fences are to be finished in accordance with the approved finish and color palette, available from the DRC.
- Fences along the ribbon trail system are not to exceed 42 inches and are to be located consistent with Community Plan and Homesite Matrix setback criteria. All fences are to use an integrated landscape treatment of trees, grasses, shrubs and vines to blend fencing into the hilltop landscape.
- The following is a list of approved types of edge treatments, refer to Homesite Matrix for specific standards regarding maximum heights, setback and treatments in front yard, side/rear yard and alley areas.

WALLS**Approved wall types include:**

- » Board formed concrete
- » Stucco – 18” to 42”
- » Low stone – 18” to 42”

FENCES OR FENCE/WALL COMBINATIONS**Approved fence, fence/wall combinations and/or planting designs include:**

- » Stained wood slat or board fencing – 36” to 6 feet
- » Split rail – 36’-42”
- » Wood/brick combinations – 36” to 6 feet
- » Informal shrub screen, 3 feet to 6 feet

GATES AND MONUMENTS**Approved gate designs and associated monuments include:**

- » Stained, rustic, wood picket, single or double leaf, 42” to 6 feet,
- » Stained, rustic board fencing, single or double leaf, 42” to 6 feet
- » Handcrafted, metal, single or double leaf, 42” to 6 feet
- » Tumbled brick and/or stone monuments, maximum height 6 feet

Inappropriate fence, gate and wall types include:

- » Concrete block
- » Chain link
- » High walls (over 4 feet) that utilize solid, opaque masonry designs
- » Brick designs that utilize pre-cast concrete or manufactured brick with a sharp, machined edge

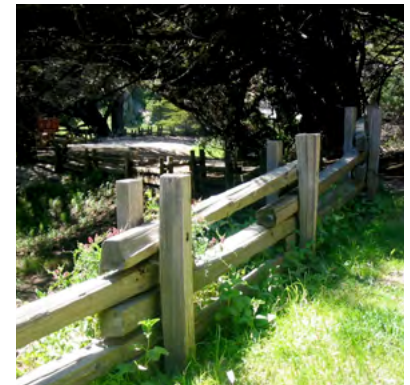
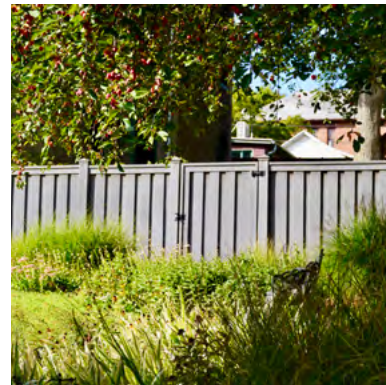

Terraine fencing treatments draw from the informal, rustic rural western ranch traditions

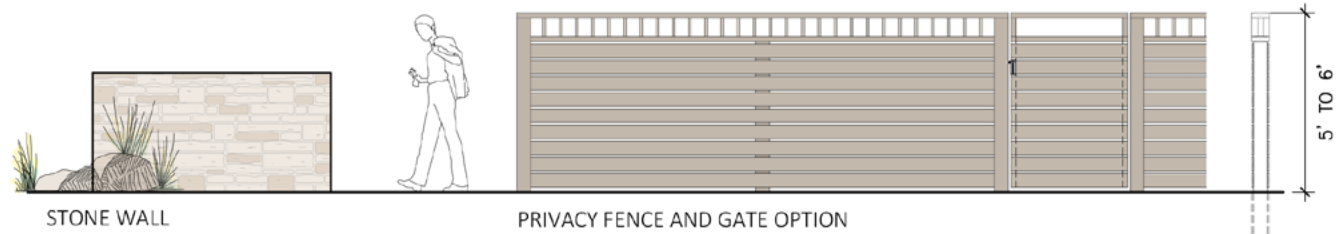

STONE WALL

PRIVACY FENCE AND GATE OPTION

DOUBLE-SIDED
ONE-SIDED

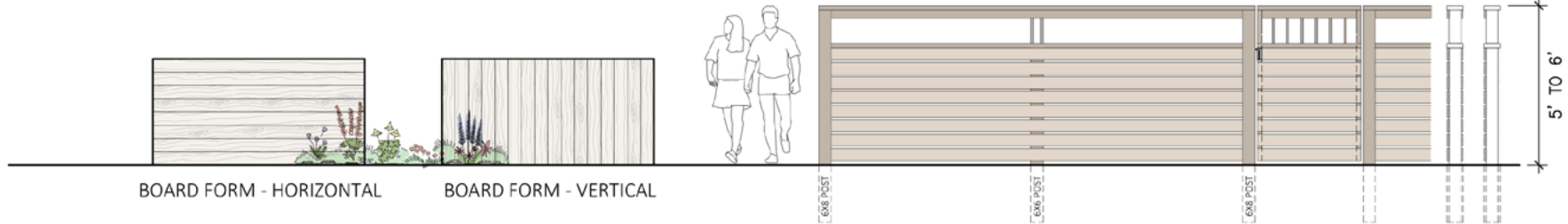

BOARD FORM - HORIZONTAL

BOARD FORM - VERTICAL

PRIVACY FENCE AND GATE OPTION
"The Great Wide Open"

DOUBLE-SIDED
ONE-SIDED

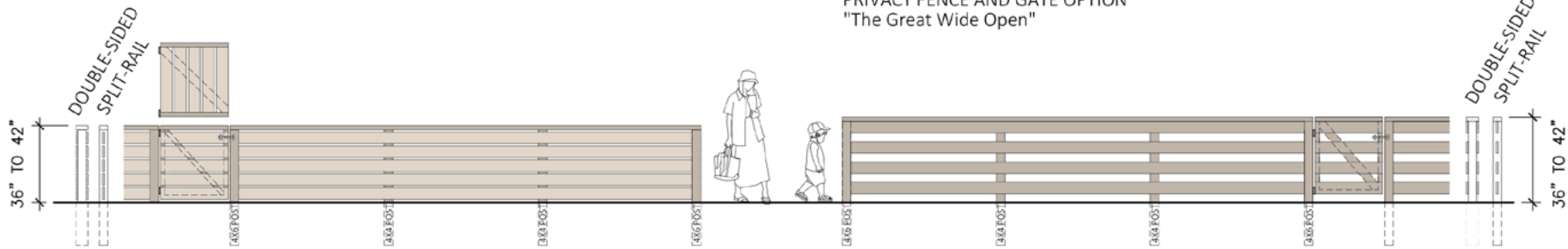

OPAQUE FENCE AND GATES

RAIL FENCE AND GATE

DOUBLE-SIDED
SPLIT-RAIL

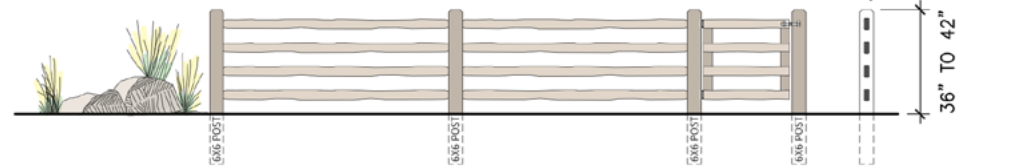

RUSTIC RAIL FENCE AND GATE

SPLIT-RAIL

Terraine fence and wall palette



Fence designs and hardware are to draw from rural western ranch traditions



EDGE TREATMENTS IN SPECIFIC HOMESITE AREAS

- Placement of all edge treatments is to comply with the Community Plan, Homesite Matrix setback criteria and any additional criteria noted on Neighborhood Plans (as applicable).

FRONT YARD AREA

- Edge treatments (fences and walls) in front yard areas are to be between 36 and 42 inches in height. Placement of fences and walls is to respond to street tree locations, guest parking areas and/or sidewalks and are to be combined with an integrated planting treatment.
- Gates and/or entry monuments may be used in combination with front yard treatments (shrub screens and/or fences) but may not exceed 5 feet in height.

SIDE / REAR YARD AREAS

- Privacy fences (any fence over 42") within side and back yard areas may be used a minimum of 5 feet behind front façade, and 3 feet back from side street property line, utilizing a semi-opaque fence or wall design heavily planted with shrubs and vines.
- The height transition from the front yard edge treatment to the side/rear yard treatment is to be gradual and utilize stepped height transitions. Angled fences are not permitted.

ALLEY AREAS

- An edge treatment along the rear yard property line along the alley is to be a minimum of 48" and a maximum of 6 feet high to create a defined "edge" to the alley. Refer to setback criteria for placement of fences or landscape treatments. All fences along alleyways are to be combined with shrubs and vines that cover a minimum of 50% of the wall/fence façade at maturity.
- Gates and monuments may be used along alleyways provided they are a maximum of 6 feet in height.

2.13 LANDSCAPE STRUCTURES AND SITE FURNISHINGS

Landscape structures (gazebos, pavilions, arbors, trellises, greenhouses etc.) are to be designed to appear as extensions and/or additional building components of the Home and are to help define outdoor rooms. In general, landscape elements and furnishings are to be used to link and/or connect collections of buildings or to create focal points in the landscape, add texture and color.

- Landscape structures may be used to ameliorate the climate and create shade, shadow and texture.
- Structures are to be designed together with a planting design that softens and integrates the structure with the outdoor areas.
- The height, color, materials and style used for outdoor structures should be the same, similar to or compatible with the Architectural Style of the home.
- In general, the same Guidelines that apply to architecture apply to the design of landscape structures.
- Play structures or furnishings are to be constructed of natural materials and painted, stained or finished in accordance with the approved color palette.

2.14 EXTERIOR LIGHTING

Exterior lighting is permitted to the extent required for safety and security, but is to be kept to a minimum to preserve the visibility of the night sky.

- Pole-mounted luminaires, sconces and path lights are to be minimized, but may be used to illuminate backyard areas for nighttime use when integrated with landscape planting that obscures the post. Mounting heights are to be no higher than necessary to achieve lighting objectives.
- The use of full cut off lighting designs at garages is required in order to provide subtle alley illumination.
- “Full cut off” lighting luminaires that do not allow for uplighting are required. All direct light is to shine a minimum of 20 degrees below the horizontal plane. Uplighting of vegetation is not allowed and may only be permitted when not visible from off-site and when light does not impact the quality of the nighttime sky.
- Low-intensity light sources are to be used, preferably with translucent or frosted glass lenses. Lamps that complement the community lighting system are allowed for site lighting and are to be shielded with simple shade devices. Lower intensity bulbs are to be used in architectural fixtures such as step lights.
- The color of light is to be similar to that of daylight, that of “warm” colored light rather than “blue” light. Sources are to be color corrected to achieve this result.
- Lighting that uses timing mechanisms to shut off lights automatically is encouraged in parking and/or service areas. Motion detectors may be used, where appropriate. Infrared sensors are preferable to ultrasonic types.
- After installation of exterior lighting, all lighting is to be tested to ensure that there is no light spill in unintended areas.
- The use of incandescent lighting is to be avoided because of its inefficient energy use. Low voltage lamps, LED’s, and/or compact fluorescent lamps (CFL’s), which are four times more efficient and last ten times longer than incandescents, are good alternatives. If incandescent bulbs are used they are to be installed with dimming controls.
- The use of alternative power technologies, such as solar photovoltaics or fuel cells, for lighting is encouraged.



Terraine lighting design and materials

2.15 WATER FEATURES – POOLS AND FOUNTAINS

Water features are to be designed to complement the architecture and to enrich landscaped areas. Water features are to draw upon the natural design aesthetic and the architecture at Terraine.

- Water features should complement the overall landscape design and may utilize regional materials such as natural stone, chipped stone and/or brick.
- Swimming pools, hot tubs and spas will be approved on a Homesite by Homesite basis, are to be in scale with the Homesite size and may only be located within backyard areas that are not visible from the public areas and/or adjoining Lots.
- Swimming pools, hot tubs and spas are to be visually connected to the residence through the use of privacy fences or walls and courtyards.
- Water features are to be designed using recirculating water. Pumps and other equipment are to be screened from view and housed to prevent any noise emission.

2.16 ADDRESS MARKERS

Address numbers are to be clearly posted along the street in accordance with local emergency response requirements. Address numbers may be attached to front yard fences, porches and/or gates or placed on address posts located within 2 feet of the front entry path or driveway. Address posts are to complement fence designs used throughout the Community and are to be a maximum of 42” feet high. In addition to those posted along the street, Owners are encouraged to post addresses and names on alley-accessed garage buildings.

Address numbers are to be made of cast-iron and painted black. Brass finishes are not permitted. Address fonts are to be consistent or related to that found on community signs throughout Terraine.

2.17 UTILITIES AND SERVICE AREAS

- Trash disposal, outdoor work areas, utility meters and connections, transformers, air conditioning units, pool/spa equipment and similar above-ground devices are to be completely screened from off-site views by the use of architectural devices and/or plant materials. Where feasible, these areas are to be integrated into the building's architecture. Noise emission from such devices is to be contained.
- In order to minimize site disturbance, all utility lines are to be located underground, and when feasible, under or along driveways. Utility alignments are to minimize grading.
- Service, trash and storage areas are to be made inaccessible to animals. Trash storage areas are to be easily accessible to service personnel and contain odors. Trash storage areas are to be sized to accommodate a minimum of two full-sized garbage containers.
- Comply with the City of West Jordan's waste disposal contractor for guidelines for bin placement.
- Utility boxes, including meters, are to be attached to or incorporated into the building's architecture and screened from off-site views. All exposed metal related to utilities (meters, outlet covers, etc.) is to be painted to match adjacent natural and/or building materials.



TERRAINE PATTERN BOOK

3.0

RESIDENTIAL ARCHITECTURE GUIDELINES

The following section sets forth Guidelines and standards for all work relating to the new construction of building(s), and/or the renovation, alteration or addition to the exterior finish of an existing structure, including Building

Heights, massing, color, materials and sustainability measures. These Guidelines are to be used in concert with the Terraine Community Plan and Matrix, which describes development standards pertaining to each Homesite.

3.1 ESTABLISHING THE ARCHITECTURAL FABRIC– THE ARCHITECTURAL DESIGN OBJECTIVES FOR TERRAINE

Terraine has been planned as a series of neighborhoods that draw from regional western vernacular. Architectural Styles, described in this section, build on contextual western traditions and include four key Styles from which to design homes: **Craftsman, Mining, Farmhouse, and Prairie**. The architecture of Terraine is to reflect the small town informality and lifestyle based on the following architectural design principles:



Draw from the mining and western architectural vernacular traditions to create informal, relaxed, simple building designs, rather than formal, classical types. While formal or classical elements may be employed, buildings are to be designed to reflect the casual “ranch” environment, rather than an “in-town” look. Designs should respond to the size and unique attributes of the particular Homesite.



Building massing should be designed as a collection of simple forms. Buildings are to incorporate one or more roofs, offsets, and porch elements to create texture, shade and shadow, and to establish informal (sometimes asymmetrical) compositions. Building masses are to be human in scale and mass, sized to fit comfortably on the Homesite and complement the overall neighborhood framework and streetscape.



Incorporate porches and/or stoops in building designs to respond to sun orientation, views and the streetscape. The porch has evolved as one of the most important features of small-town vernacular. It establishes a neighborhood atmosphere and reinforces the informal quality of the western lifestyle. These Guidelines outline standards regarding porch placement and design considerations in order to integrate the porch vernacular in each architectural style and building design.



Design buildings with sustainable building goals in mind. Reducing consumption of materials and energy, reducing waste and making intelligent choices about how a building is used benefits both Terraine as a community and the environment.

3.2 GENERAL ARCHITECTURAL GUIDELINES

The following Guidelines apply to all Architectural Styles and design for each Homesite:

3.2.1 Building Height

In order to create a small-town atmosphere, Building Heights in Terraine are to be:

- In scale with the surrounding buildings, streetscape and size of Homesite.
- Varied from Homesite to Homesite to the extent feasible.

No building is to exceed Building Height or Story Height criteria as noted by City of West Jordan governing documents, the Terraine Community Plan, Homesite Matrix and Neighborhood Guideline documents as applicable.

Building Height Measurement:

As defined by the City of West Jordan, Ordinance No. 21-19, Building Height (exclusive of chimneys and minor roof projections) shall be measured as the

“...The vertical distance under the roof or any roof element to the nearest measure of existing grade. Maximum height may be maximum number of stories. A story is equal to twelve feet (12).”

All Building Heights shall conform to local, state and/or federal guidelines and any other applicable governing documents for Terraine.

3.2.2 Chimneys and Roof Projections

Chimney designs and/or roof projections are to be compatible with the structure and Architectural Style from which they project. All chimneys are to be built of masonry units or stucco (not wrapped in siding materials), drawing on prevalent western vernacular traditions. Projections such as vents and/or flues are to be located in areas not visible from the street and painted to match the roof color.

3.2.3 Outbuildings – Garages and/or Ancillary Structures

The intent at Terraine is to create an informal living environment that uses the principles behind western settlement patterns. The design and placement of outbuildings draws from this concept of adding buildings (or adapting buildings for other uses) as the need arose and over time creating a collection of related buildings. All Outbuildings are to be located within designated setback areas noted on the Community Plan and Matrix. Refer to the Community Plan for specific designations regarding garage placement and orientation.

- Outbuildings are to be subordinate to the main house and are to utilize the same or similar detailing and Architectural Style qualities. These buildings may include garages, gardening sheds, home offices, art studios or any combination of these uses.
- In general, these structures are to use the same Architectural Style as the main Residence.
- Outbuildings and/or ancillary structures may have a maximum building height per governing documents.
- Outbuildings may be freestanding or connected to the main house by outdoor rooms and/or architectural projections such as breezeways or trellises.

3.2.4 Colors and Finishes

Within the Terraine, color is to be subdued, recessive and complementary of the colors found in the surrounding grassland setting and adjacent Oquirrh Mountains. Accent colors are to be used judiciously to add warmth and visual interest. Approved color palettes for each Architectural Style specify color ranges for roof, field and accent colors and may be obtained from the Design Review Committee office.

- Building elements are to comply with the approved color palette and may have the following general color ranges:
 - » *Roofs are to be medium to dark browns, grays (galvanized), and dark reds, and may have an LRV (light reflective value) of 60 or lower.*
 - » *Walls are to subdued earth tones (a range of browns, ochres, tans, grays and/or muted colors found in the surrounding environment), and are to have an LRV value of 60 or lower.*
 - » *Trim and accent colors are to be similar hues as the main. House color but darker in value (dark browns, dark green, dark reds, and/or blacks).*
 - » *Wood fence elements are to be stained or painted in earthtone colors and left to weather naturally in accordance with the DRC approved fence palettes.*
- In order to ensure clean and healthy indoor air quality, the use of paints, coatings and other finishes with low levels of Volatile Organic Compounds (VOCs) is required for use on interior and exterior walls, details, and other elements.

3.2.5 Building Materials Selection

One of the main goals in sustainable design is to select and specify environmentally preferable materials. In general, criteria for selection should include the conventional selection criteria such as strength, cost, appearance and suitability.

In addition, the following criteria should be considered when choosing building materials: Environmental impact, durability and toxicity. Using the following sustainable Guidelines to select building materials, while still retaining the rustic, informal qualities of Terraine is encouraged:

- Incorporate recycled content materials into the overall building materials selection to the extent feasible.
- Use building materials that may be recycled at the end of their useful life.
- Preference for wood based materials certified in accordance with the Forest Stewardship Council Guidelines (FSC).
- Substitute Rapidly Renewable building materials (such as bamboo flooring, wool carpet, strawboard, cotton batt insulation, linoleum flooring, poplar OSB, and sunflower seed board) for finite raw and long cycle renewable materials.
- Preference for building products from local and regional resources (within 500 miles) to support local economies and to reduce the environmental impacts of transporting materials over long distances.
- Incorporate salvaged materials into the building design. Materials could include structural timbers such as beams and posts, hardwood flooring, doors and frames, cabinetry, furniture, and brick and decorative detailing salvaged from older buildings that can be refinished and/or remilled.
- Use building materials that minimize the emission of Volatile Organic Compounds (VOC's) and other pollutants.

3.2.6 Mechanical Systems

An energy Consultant and/or Architect is to establish the minimum level of energy efficiency that the building and its systems will achieve at Terraine. All building designs are required to assess the homes' energy efficiency utilizing the Home Energy Rating System (HERS) index to meet Terraine's minimum efficiency standards (Refer to DRC required performance standards).

The need for air conditioning may be reduced through effective ventilation design and the use of trees and architectural devices for shading. Such designs would reduce heat absorption and maximize exposure to summer breezes by facilitating internal air circulation, effective shading and maximizing exposure to summer breezes. Additionally, the incorporation of the following sustainable design principles is strongly encouraged:

- Using on-site renewable energy sources, such as solar energy, as alternatives to fossil fuel energy sources.
- Providing a high level of individual occupant control for thermal, ventilation and lighting systems. Occupancy sensors and time clock controls may also be incorporated into the building's mechanical design to reduce energy usage.
- Selecting a building's orientation, massing and fenestration design, to maximize effective daylighting to reduce the building energy requirements, without increasing glare and/or electric lighting loads that offset glare. The selection and extent of window glazing should vary, depending on the criteria required by the window's location, including solar heat gain, energy performance, daylighting, views and glare factors. Exterior sun controls (including porches, overhangs, trellises, balconies and shutters) may be integrated into the building's fenestration design to effectively admit and block sun penetration as required.
- Using CFC-free HVAC & R base building systems. Intakes should be located and designed to assure maximum levels of indoor air quality. The use of carbon dioxide monitoring sensors is encouraged.

3.2.7 Skylights and Satellite Dishes

Skylights are to be integrally designed into the roof structure and located on the back of structures so as not to be visible from the street and/or adjoining Homesites. Skylight framing and glazing is to be colored or coated to match adjacent materials. Subject to applicable federal law, Owners and Contractors are encouraged to locate satellite dish antenna so as to be unobtrusive from the street and/or adjoining Homesites.

3.2.8 Solar Equipment

Solar power generating equipment is encouraged but should be integrated into the architectural design of the roof structure and in areas less visible from the street or neighboring Homesites. All solar designs and locations are to be reviewed and approved by the Design Review Committee.

3.3 THE TERRAINE HOME – ARCHITECTURAL STYLES FOR A SMALL WESTERN TOWN

The Terraine Architectural Patterns illustrate the key elements and design strategies employed in the region's most enduring neighborhoods. The Guidelines within this section are to be used as a design tool in the creation of neighborhoods with a distinctive regional western character and quality of place. The goal is the creation of a neighborhood composed of a rich variety of contextual architectural styles with a consistent quality of character and detail. The four approved styles for Terraine are ***Craftsman, Mining, Farmhouse, and Prairie***. This section of the Guidelines details the approved styles by presenting the following six essential components of each style:

01 

ESSENTIAL ELEMENTS

A general description of the style, the style's history, culture, components, and character.

02 

MASSING & COMPOSITION

A summary of key massing types and typical window and door compositions.

03 

WALL CONSTRUCTION, ROOFS & EXTERIOR WALLS

A summary of approved roof types and materials, as well as approved exterior materials.

04 

EAVE & TRIM DETAILS

Illustrations of common profiles of exterior eaves and trim details.

05 

WINDOWS & DOORS

Examples of various openings appropriate for the particular style.

06 

PRECEDENTS & POSSIBILITIES

Illustrations of historical precedents, possible elevations and permissible material palettes for the components of the house in a variety of finishes.

3.3.1 CRAFTSMAN

The Terraine Craftsman Style is a distinct subset of the English Arts and Crafts style which became popular in the early 20th century. This style can be seen in many traditional neighborhoods of Salt Lake and western American towns.

Low pitched roofs, deep overhangs, and sweeping porches characterize these buildings. In general, this building tradition focused on creating buildings that complimented and/or were subordinate to their setting rather than dominant using more organic and natural motifs as a guiding design approach.

ESSENTIAL ELEMENTS OF CRAFTSMAN HOMES:

- *Simple massing*
- *Shallow pitched roofs with deep overhangs*
- *Deep, broad porch elements with expressive structural components*
- *A mixture of materials such as brick, stone, heavy wood trim, shingles and siding*
- *Grouped windows*
- *Natural colors and earth tones on house body and trim*



CRAFTSMAN – MASSING & COMPOSITION

Massing and Elevation Composition is the starting point of a beautiful house.

The examples presented here are pre-approved. Deviations from these samples are encouraged, if they are within the spirit of the style. Proposals may be accompanied by examples of historical precedents or skillful implementation elsewhere.

The elevation compositions are not exclusive to the roof massing, and can be used interchangeably.







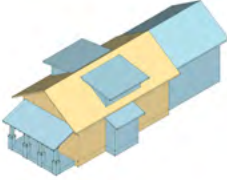

The elevation compositions are organized into bays of windows.

In this particular style, the paired windows may be substituted with bay windows that include the same or unique window compositions.

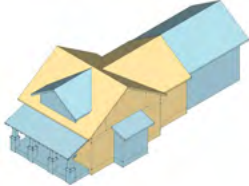
Roof forms are gables and shapes with 6:12 -8:12 Roof pitches for main roofs and 4:12 Sheds and Dormers.

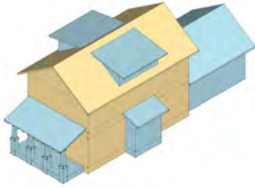
First Floor elevation is between 1 foot 6 inches and 2 feet above finished grade

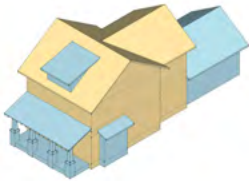
Doors and window openings are framed with trim boards and relatively flush with the wall surface

DESCRIPTION	ROOF MASSING	ARTICULATED MASSING	ELEVATION COMPOSITON
Front Facing 1 Story Gable Pitch: 6:12 to 8:12 1 Story Tall Shed or Gable Dormers			
Cross Gable 1 Story Pitch: 6:12 to 8:12 1 Story Tall Shed or Gable Dormers			
Front Facing 2 Story Gable Pitch: 6:12 to 8:12 2 Story Tall Shed or Gable Dormers			
Cross Gable, 2 Story Pitch: 6:12 to 8:12 2 Story Tall Shed or Gable Dormers			

CRAFTSMAN – WALL CONSTRUCTION

ROOF

Dimensioned architectural grade asphalt or fiberglass shingles.
Metal, narrow standing seam or 5-V panels, metal finish or painted.
Slate or synthetic slate.

CLADDING

Cladding should be consistent on all facades of primary mass. Exceptions include: secondary wings, bays and garages.

SIDING

Smooth, horizontal bevel or lap wood or fiber-cement siding, 4 to 8 inches exposure, miter-cut corners or with $\frac{5}{4}$ by 6 inch corner boards.
Wood clad houses have 8 to 10 inch wide skirt boards.

STONE

Stone: Horizontal proportioned stone larger than the human hand - laid in a coursed horizontal pattern, dry stack (minimal mortar visible).
No thin veneers.

STUCCO

Light sand finish.



Partial Elevation, 2 Story

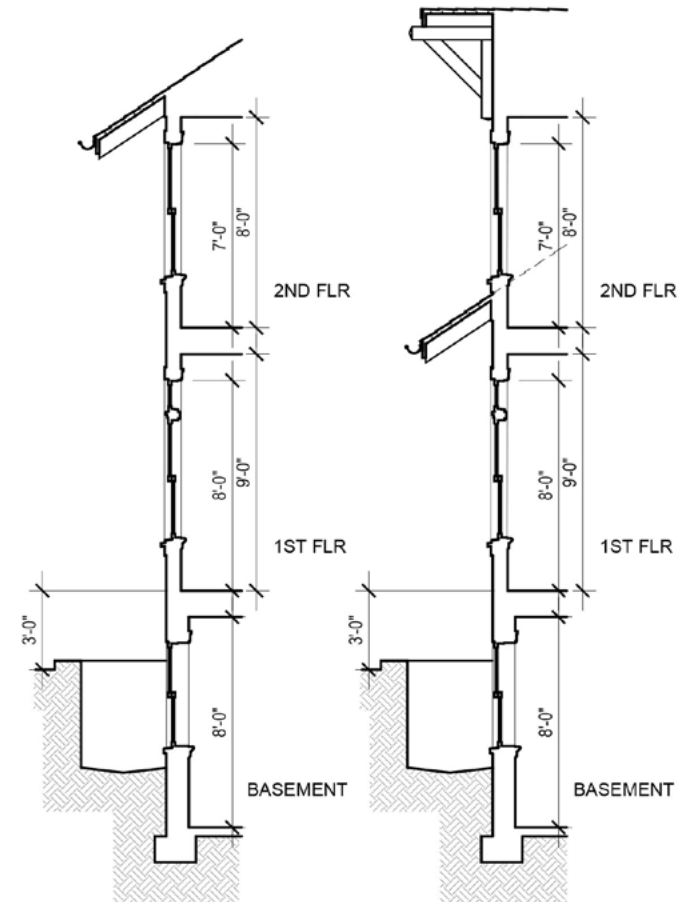

Section, 2 Story

Section, 1 1/2 Story

CRAFTSMAN – EAVES & DORMERS

EAVES

Deep eaves are a dominant characteristic. Open eaves typically have a 2x6 or 2x8 shaped rafter tail 16 to 24 inches on center. Gables feature deeper rake boards. Boxed eaves often have profiled outriggers or brackets at 24 inches on center.

TRIM

Wood, composite, cellular PVC, fiber-cement, or polymer millwork acceptable.

DORMERS

Gable pitch same as house. Shed pitch 3:12 to 4:12. No wall surface either side of shed dormer window. Window casing acts as cornerboard.

EAVES

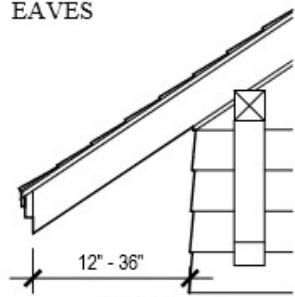

Gable Elevation
Simple Raking Eave

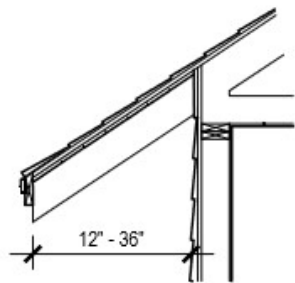

Section, Raking Eave
Open with Exposed 2x Rafter Tail

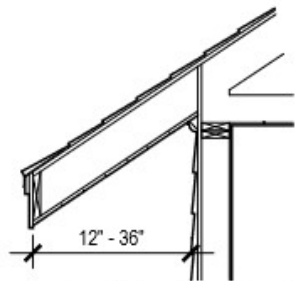

Section, Raking Eave, Closed

DORMERS



Gable Dormer

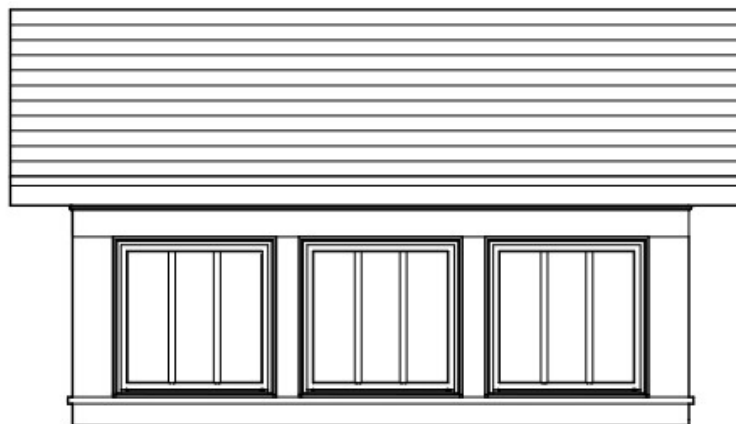

Shed Dormer

CRAFTSMAN – WINDOWS & DOORS

WINDOWS

Standard Windows

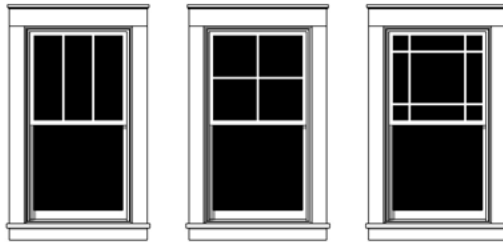

3-over-1

4-over-1

9-over-1

Window Assemblies

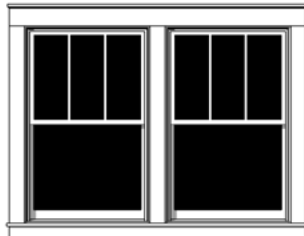

Double-hung or casement are most common to this style.

Use the same window design and proportion throughout except in special locations such as gables, dormers, or window bays.

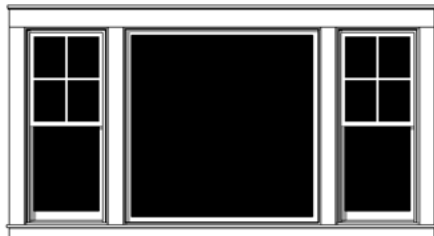

Combine windows using a minimum 3" wide trim between windows. Use the same material as jamb and header.

First-floor windows are typically taller than second and third floor windows.

WINDOW AND DOOR TRIM

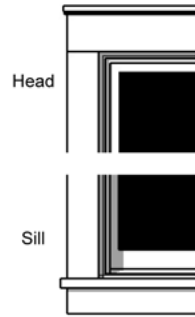

5" flat trim (square joint) plus 1" cap with projecting 1-1/2" sill and optional skirt board

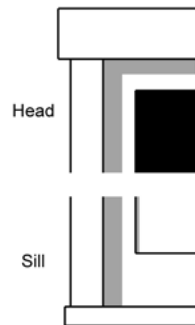

5" flat trim and 8" tall header that extends 2" beyond trim with 3" sill

DOORS

Standard Doors



Two panels

Two panels with glazing in top panel

Divided pane glazing over two panels

Divided pane glazing over single panel

Door Assemblies

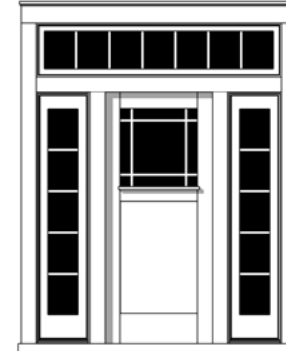

Divided pane glazing over single panel door with matching sidelights and transom

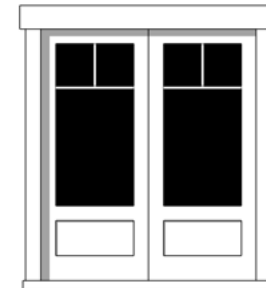

Double Doors with 3/4 lite glazing over single panel each

Standard door heights are typically 6'-8", 7'-0", or 8'-0" tall for this style.

Align door head with window head, except in special locations.

Integration of glass is recommended for exterior front entry doors, along with the use of sidelights and/or transom windows.

Recess windows and doors into wall for deep shadow effect.

CRAFTSMAN – PRECEDENTS & POSSIBILITIES



3.3.2 MINING

The Terraine Mining Style is based on the early pioneer buildings of the American west. As the western mountain towns were settled, they used simple and unadorned treatments to build practical buildings using the limited materials they found nearby. This style can be seen in many mountain towns in the western U.S. including Park City, Utah, and Telluride, Colorado.

Steeply pitched roofs, front porches and unadorned details characterize these buildings. In general, this building tradition focused on creating buildings that used local, unfinished materials to create environments that were practical and subordinate to the mountain setting.

ESSENTIAL ELEMENTS OF THE MINING HOME:

- *Simple massing with vertical and contrasting horizontal proportions*
- *Steeply pitched gable roofs, oftentimes asymmetrical compositions, with shallow pitched shed roof elements*
- *Vertical proportions for windows and doors*
- *Non stylized columns and details, from narrow posts and stout timbers and beams*
- *Rustic, unfinished materials such as clapboard or vertical plank siding, Cor-Ten Steel, Corrugated Tin and Board Formed Concrete for house body and trim*

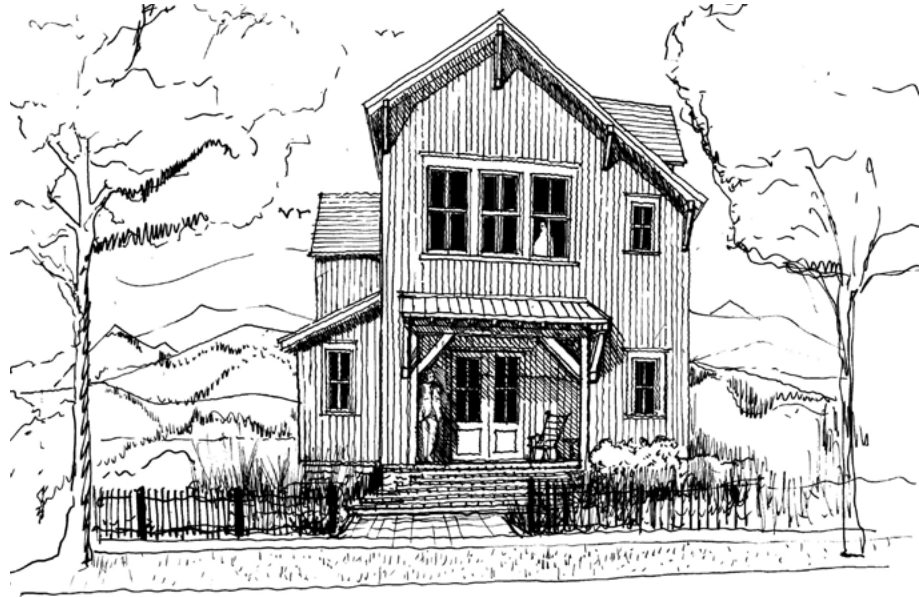

MINING – MASSING & COMPOSITION

Massing and Elevation Composition is the starting point of a beautiful house. The examples presented here are pre-approved.

Massing shall be made up of simple gable and shed roof forms. Hipped roofs are not consistent with this style.







Mining Style homes are clad in vertical siding or COR-TEN (weathered corrugated metal). Trim is black aluminum or PVC.

The elevation compositions are not exclusive to the roof massing, and can be used interchangeably.

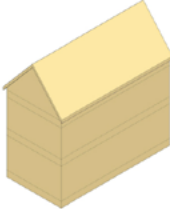
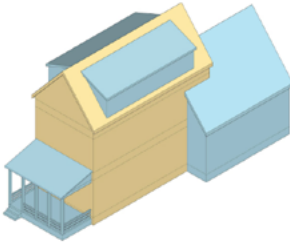
Roof forms are gables and shapes with 10:12 - 12:12 Roof pitches for main roofs and 4:12 Sheds and Dormers.

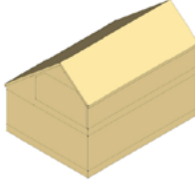
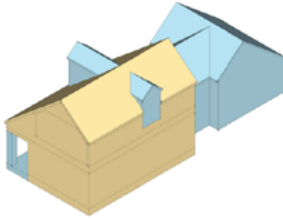
First Floor elevation is min. 2 feet above finished grade at front entrance.

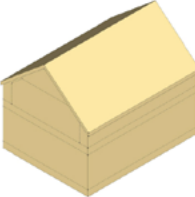
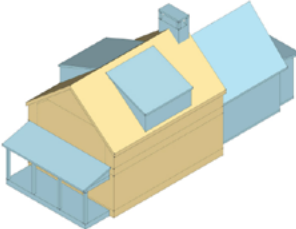
Doors and window openings are framed with trim boards and relatively flush with the wall surface

DESCRIPTION	ROOF MASSING	ARTICULATED MASSING	ELEVATION COMPOSITION
Narrow Front Gable Pitch: 10:12 -12:12 2 to 2.5 Story Tall Shed or Gable Dormers			
Front Facing Asymmetrical Gable Pitch: 10:12 -12:12 1.5 to 2 Story Tall Shed or Gable Dormers			
Front Facing Gable Pitch: 10:12 to 12:12 1.5 to 2 Story Tall Shed or Gable Dormers			

MINING – WALL CONSTRUCTION

ROOF

Metal, narrow standing seam, 5-V panels, or corrugated encouraged. Dimensioned architectural grade asphalt or fiberglass shingles.

CLADDING

Cladding should be consistent on all facades of primary mass. Exceptions include: secondary wings, bays and garages.

SIDING

Metal siding encouraged, narrow standing seam, metal panels or corrugated. Smooth or rough sawn, butt-joint board wood or fiber-cement siding, Rough sawn board on board, alternating 4" and 8". Corners use $\frac{3}{4}$ " by 4 inch corner boards. Use 8 to 10 inch-wide skirt boards.

STONE

Stone: Horizontal proportioned stone larger than the human hand, laid in a coursed horizontal pattern, dry stack (minimal mortar visible) No thin veneers.

CONCRETE

Board-formed concrete is encouraged in foundation walls, flooring, porches and in secondary wall surfaces.

STUCCO

Light sand finish.

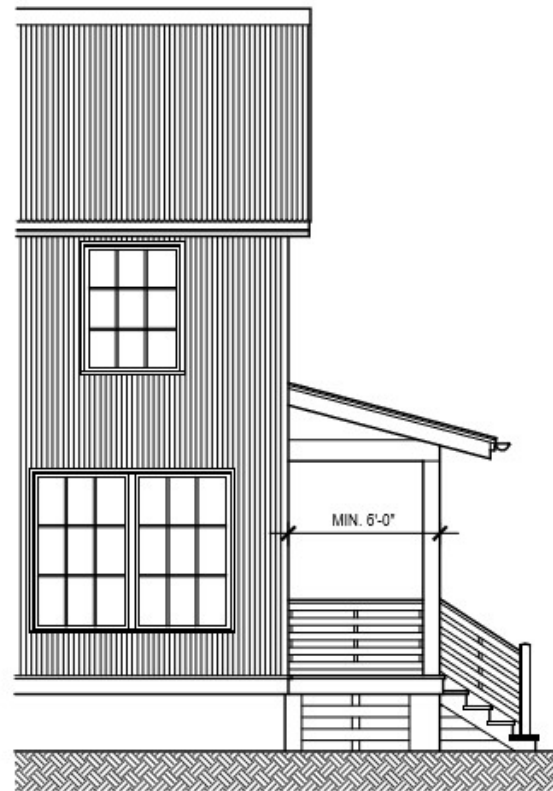

Partial Elevation, 2 Story

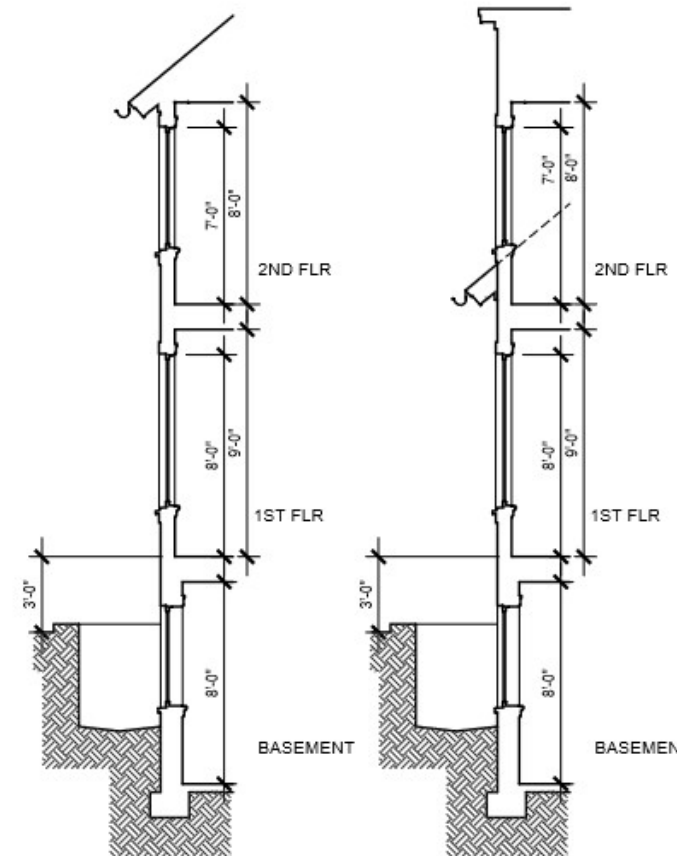

Section, 2 Story

Section, 1 1/2 Story

MINING – EAVES & DORMERS

EAVES

Shallow eaves are a dominant characteristic and have a minimum depth of 6 inches. Open eaves typically have a 2x6 or 2x8 shaded rafter tail, 16 to 24 inches on center. Gables feature shallow rake boards. Smooth fiber-cement board. Tongue and groove planks in wood, PVC, or similar.

TRIM

Wood, composite, cellular PVC, fiber-cement, or polymer millwork acceptable. Metal fascias are encouraged with the use of metal siding. 4" - 6" acceptable.

DORMERS

Gable pitch same as house. Shed pitch 3:12 to 4:12. No wall surface either side of window. Window casing acts as cornerboard.

EAVES

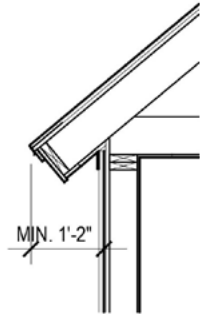

Sloped Closed Eave

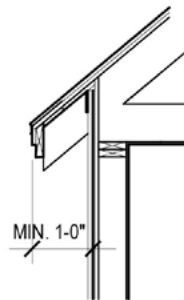

Open Eave, Exposed Shaped Rafter Tails

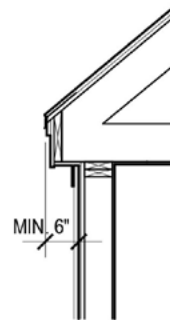

Boxed Eave

DORMERS

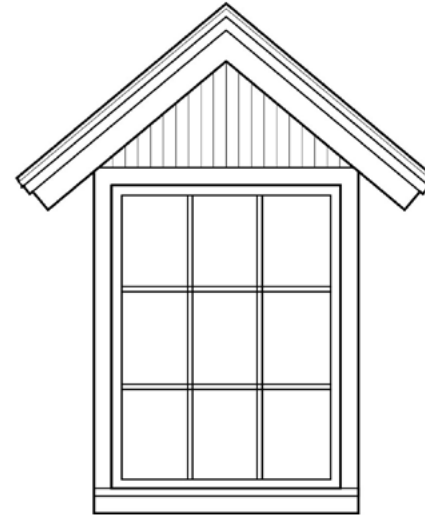

Gable Dormer

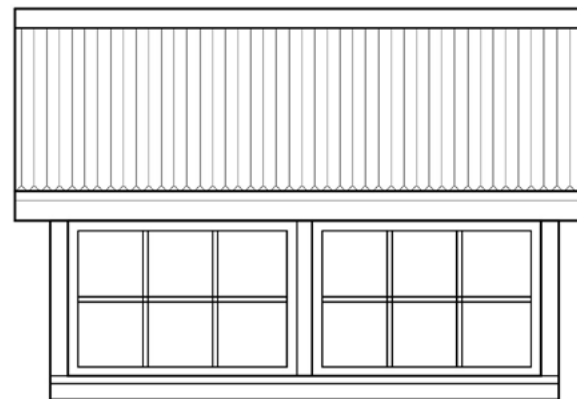

Shed Dormer

MINING – WINDOWS & DOORS

WINDOWS

Standard Windows

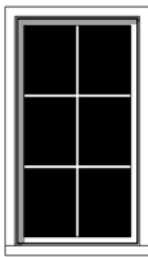

6 Lite

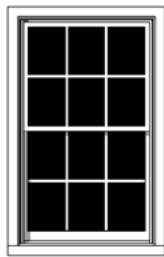

6-over-6

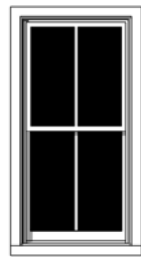

2-over-2

Window Assemblies

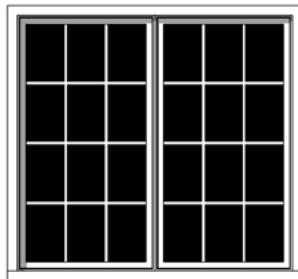

This style often includes ganged windows that are connected using a manufactured mull.

It is acceptable to combine windows using a narrow trim piece between windows. Use the same trim material as is used on jamb and header to match.

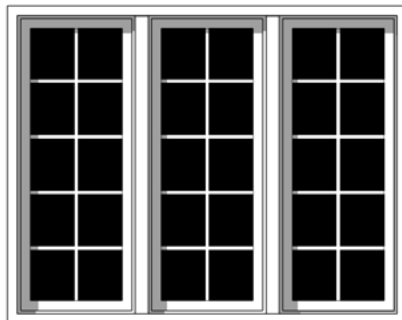

WINDOW AND DOOR TRIM



3" flat trim with matching 3" sill that projects forward

Double-hung or casement windows with divided lites are most common to this style.

Window lites typically have vertical proportions.

Use the same window design and proportion throughout except in special locations such as gables, dormers, or window bays.

First-floor windows are typically taller than second and third floor windows.

DOORS

Standard Doors

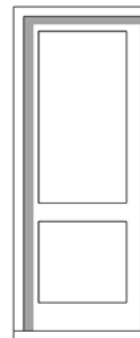

Two panels

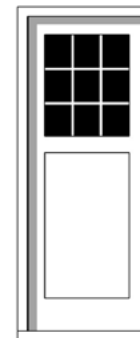

9 lite pane glazing over single panel

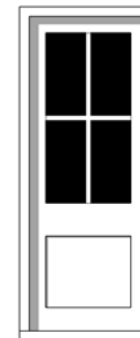

4 lite pane glazing over single panel

Door Assemblies

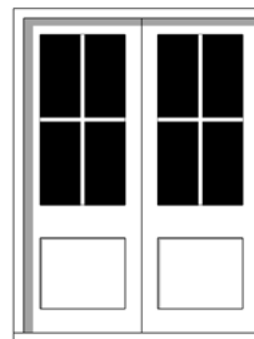

Double Doors with 4 lite glazing over single panel each door

Standard door heights are typically 8'-0" tall for this style.

Align door head with window head, except in special locations.

Recess windows and doors into wall for deep shadow effect.

External muntin bars is preferred. Muntin bars between panes is not permitted.

Use traditional profiles.

Often, glass is incorporated in exterior front entry doors.

MINING – PRECEDENTS & POSSIBILITIES



3.3.3 FARMHOUSE

The Terrain Farmhouse Style has roots in the humble beginnings of the modest rural houses built by American pioneers throughout the 1700's and 1800's. These houses were usually single floor and rectangular dwellings made of local materials ranging from wood, stone, and mudbricks depending on the home's location. This style prioritizes simple massing forms, practicality and rustic charm. This style can be seen in many of the agricultural and ranching rural towns of the west and Midwest and maintains a strong sense of symmetry and classical proportions.

ESSENTIAL ELEMENTS OF THE FARMHOUSE STYLE:

- *Simple, rectangular massing, oftentimes 1 ½ to 2½ stories tall*
- *Clapboard or board and batten siding*
- *Large, long covered porch elements that wrap buildings*
- *Regularly spaced, symmetrical, vertically oriented windows*

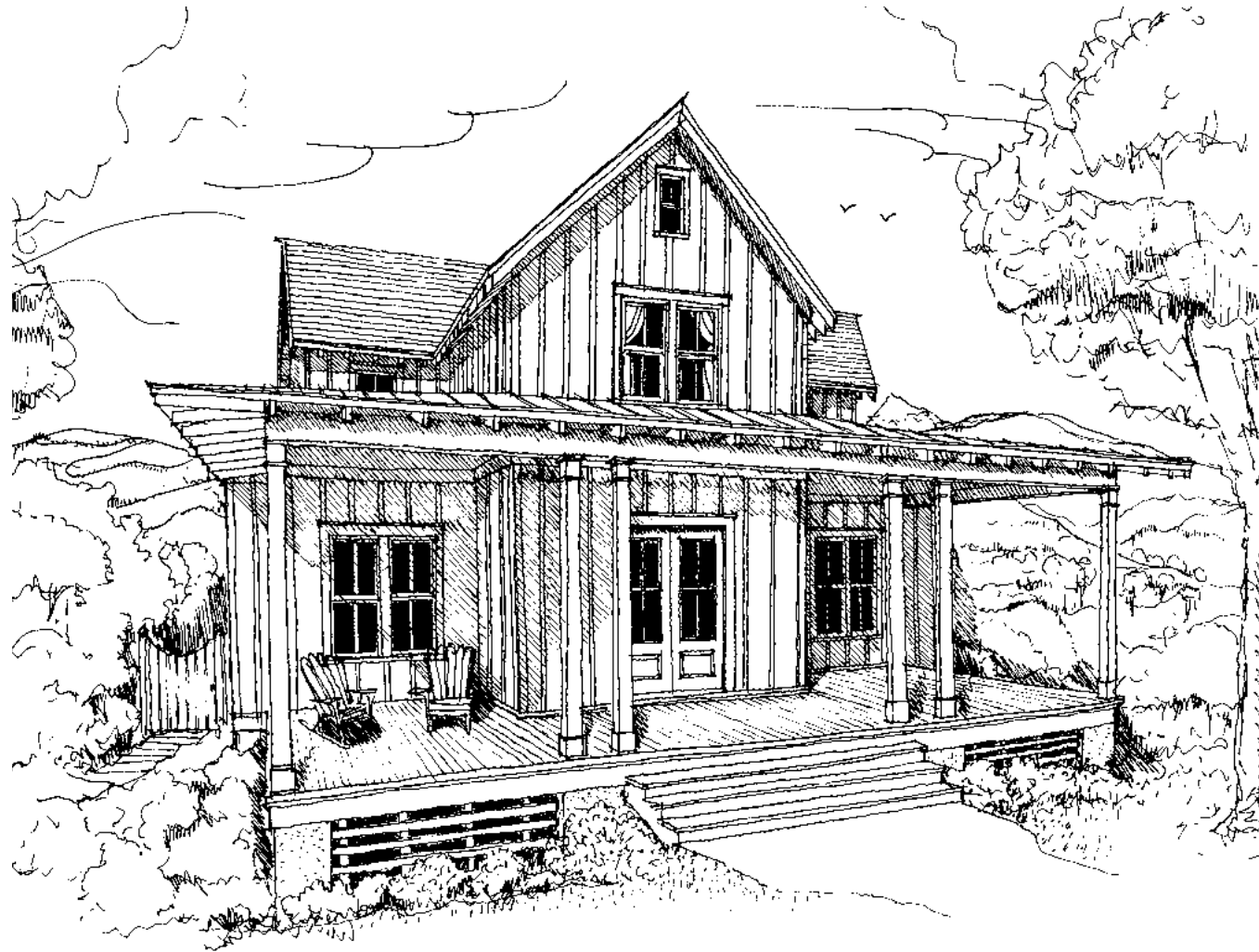

FARMHOUSE – MASSING & COMPOSITION

Farmhouse Style prioritizes simple massing forms, practicality and rustic charm. It draws from aesthetics of rural architecture but maintains a strong sense of symmetry and classical proportions.

The Farmhouse style can have deep porches added to the volume of the Main Body. It has typically a gable roof with a 8 to 12:12 over the main body and a 3 to 4:12 over porches and secondary masses. Porches can wrap around either one or more sides and typically stay as 1 story porches.

Deviations from these samples are encouraged, if they are within the spirit of the style. Proposals may be accompanied by examples of historical precedents.

The elevation compositions are not exclusive to the roof massing, and can be used interchangeably.

Roof forms are gables and shapes with 8:12 - 12:12 Roof pitches for main roofs and 3:12 Sheds and Dormers.

Minimum Floor to ceiling Heights are 10 feet for the first floor and 9 feet for the second floor.

First Floor elevation is min.2 feet above finished grade at front entrance

Doors and window openings are framed with trim boards and relatively flush with the wall surface

DESCRIPTION	ROOF MASSING	ARTICULATED MASSING	ELEVATION COMPOSITION
<p>Front Gable L Pitch: 8:12 to 12:12 1 Story Tall Shed or Gable Dormers</p>			
<p>Cross Gable Pitch: 8:12 to 12:12 1 to 1.5 Story Tall Shed or Gable Dormers</p>			
<p>Cross Gable Pitch: 8:12 to 12:12 2 Story Tall Shed or Gable Dormers</p>			
<p>Cross Gable w/ Center Front Gable Pitch: 8:12 to 12:12 2 Story Tall Shed or Gable Dormers</p>			
<p>Front Gable L Pitch: 8:12 to 12:12 2 Story Tall Shed or Gable Dormers</p>			

FARMHOUSE – WALL CONSTRUCTION

ROOF

Dimensioned architectural grade asphalt or fiberglass shingles on main roof. Metal, narrow standing seam or 5-V panels on porch roofs.

CLADDING

Cladding should be consistent on all facades of primary mass. Exceptions include: secondary wings, bays and garages.

SIDING

Smooth, board and batten wood or fiber-cement siding, battens 12 to 16 inches O.C., or smooth, horizontal bevel or lap wood or fiber-cement siding, 4 to 8 inches exposure.

Miter-cut corners or with $\frac{5}{8}$ by 6 inch corner boards.

Wood clad houses have 8 to 10 inch wide skirt boards.

STONE

Stone: Horizontal proportioned stone larger than the human hand - laid in a coursed horizontal pattern - dry stack (minimal mortar visible)

No thin veneers.

STUCCO

Light sand finish.

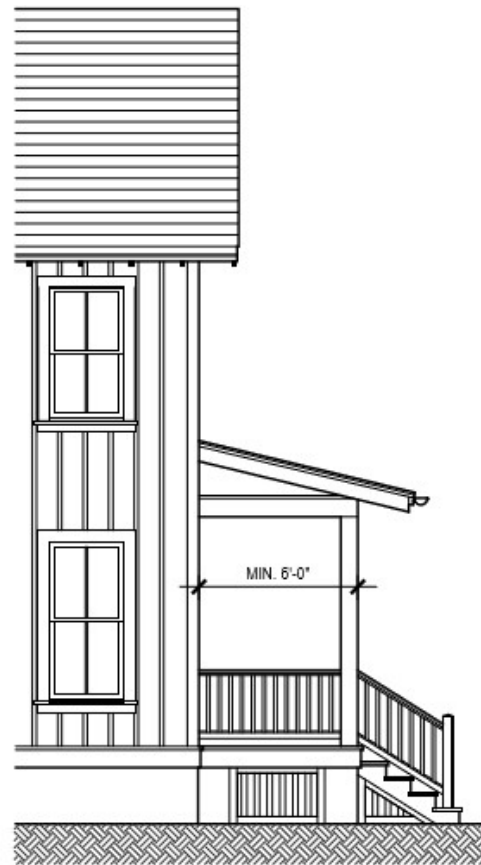

Partial Elevation, 2 Story

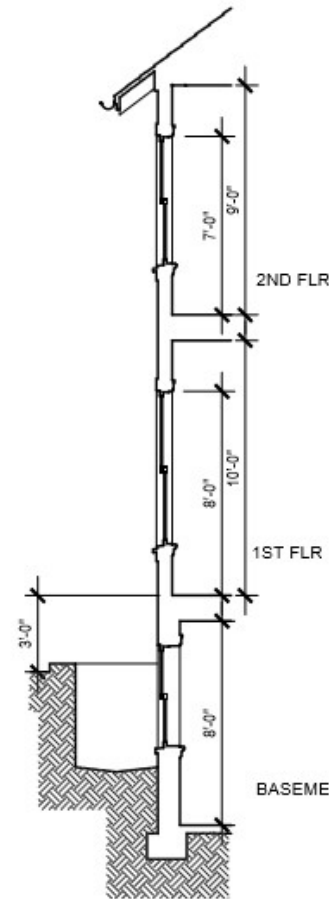

Section, 2 Story

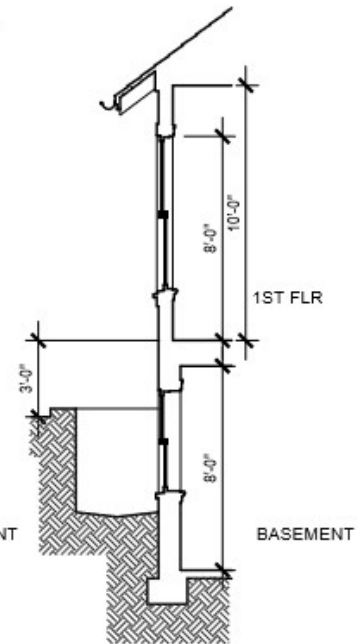

Section, 1 Story

FARMHOUSE – EAVES & DORMERS

EAVES

Shallow eaves are a dominant characteristic and vary in depth from 8 to 18 inches deep.
 Open eaves typically have a 2x6 or 2x8 shaded rafter tail, 16 to 24 inches on center.
 Gables feature deep rake boards with expressive trim.
 Smooth fiber-cement board.
 Tongue and groove planks in wood, PVC, or similar.

TRIM

Wood, composite, cellular PVC, fiber-cement, or polymer millwork acceptable.

DORMERS

Gable pitch same as house.
 Shed pitch 3:12 to 4:12.
 No wall surface either side of window.
 Window casing acts as cornerboard.

EAVES

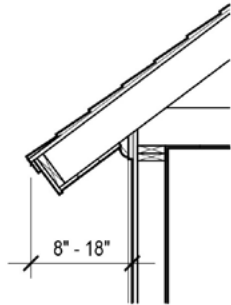

Sloped Closed Eave

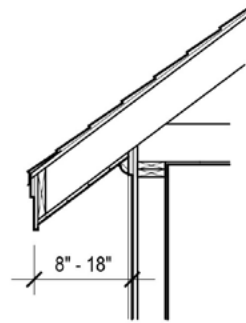

Plumb Closed Eave

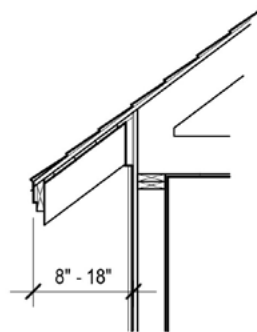

Open Eave, exposed shaped rafter tails

DORMERS



Gable Dormer

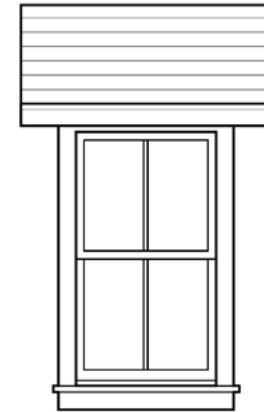

Shed Dormer

FARMHOUSE – WINDOWS & DOORS

WINDOWS

Standard Windows

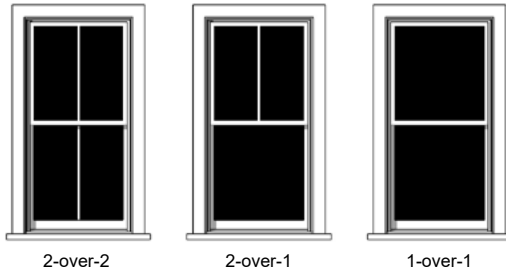

Window Assemblies

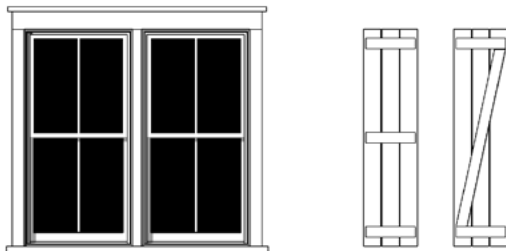

Combine windows using a min. 3" wide trim between windows. Use the same trim material as is used on jamb and header.

Shutter size should equal one-half the width of the window and equal the height.

Double-hung or casement are most common to this style.

Farmhouse window lites typically have vertical proportions.

Use the same window design and proportion throughout except in special locations such as gables, dormers, or window bays.

First-floor windows are typically taller than second and third floor windows.

WINDOW AND DOOR TRIM

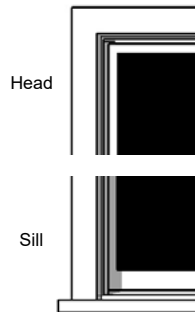

4" flat trim with projecting 2" sill

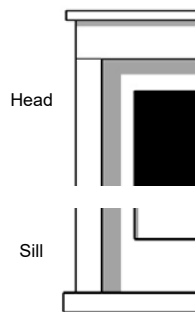

4" flat trim and 6" tall header plus 1-1/2" cap that extends 1" beyond trim with 3" sill

DOORS

Standard Doors

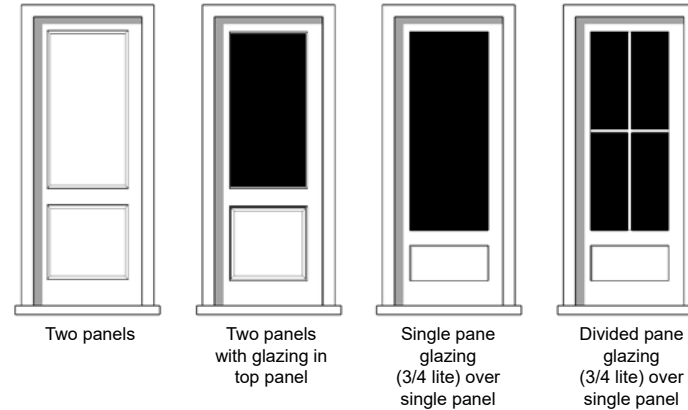

Door Assemblies

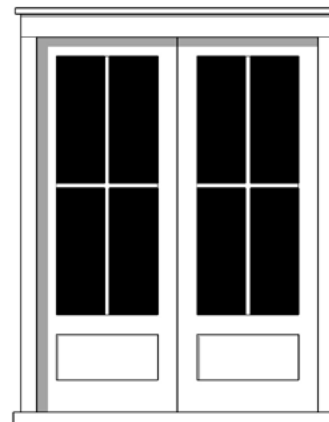

Double Doors with 3/4 lite glazing and divided panes over single panel each door

Standard door heights are typically 8'-0" tall for this style.

Align door head with window head, except in special locations.

Recess windows and doors into wall for deep shadow effect.

External 3/4-inch muntin bars is preferred. Muntin bars between panes is not permitted.

Use traditional profiles.

Often, glass is incorporated in exterior front entry doors.

FARMHOUSE – PRECEDENTS & POSSIBILITIES

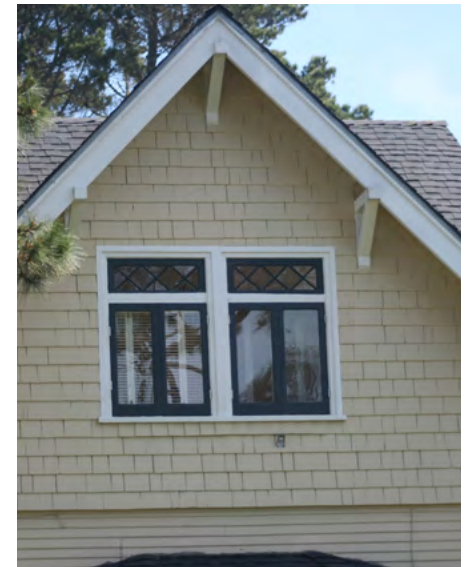

3.3.4 PRAIRIE

The Terraine Prairie Style is a distinct American style inspired by the broad, flat landscape of America's Midwest. This style can be seen in many traditional neighborhoods of Salt Lake and western American towns.

Low pitched roofs, deep overhangs, and ganged windows characterize these buildings. In general, this building tradition focused on creating buildings that complimented and were subordinate to the landscape setting rather than dominant using more horizontal masses and lines as a guiding design approach.

ESSENTIAL ELEMENTS OF PRAIRIE HOMES:

- *Simple massing*
- *Shallow pitched roofs with deep overhangs*
- *A mixture of materials such as brick, stone, shingles and siding*
- *Ganged windows*
- *Natural colors and earth tones on house body and trim*



PRAIRIE – MASSING & COMPOSITION

Massing and Elevation Composition is the starting point of a beautiful house. The examples presented here are pre-approved.

Essential Elements to the Prairie style include but are not limited to: Simple massing, shallow-pitched roofs with deep overhangs, mixture of materials such as brick, shingles, siding, and stone, ganged windows, and natural earth tone colors on house body and trim

Deviations from these samples are encouraged, if they are within the spirit of the style. Proposals may be accompanied by examples of historical precedents .

The elevation compositions are not exclusive to the roof massing, and can be used interchangeably.

Typical Floor to ceiling Heights are 10 feet for the first floor and 9 feet for the second floor.

Roof forms are hipped with 3:12 - 5:12 Roof pitches

First Floor elevation is min. 2 feet above finished grade at front entrance.

Doors and window openings are framed with trim boards and relatively flush with the wall surface

DESCRIPTION

ROOF MASSING

ARTICULATED MASSING

ELEVATION COMPOSITON

Hip Roof
Pitch: 3:12 to 5:12
3 Story Tall

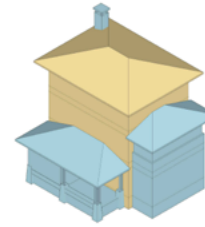

Hip Roof
Pitch: 3:12 to 5:12
2 Story Tall

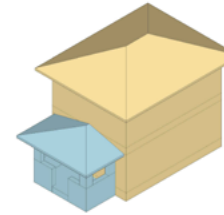
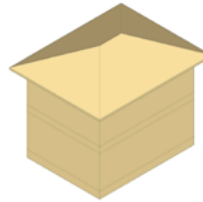

PRAIRIE – WALL CONSTRUCTION

ROOF

Dimensioned architectural grade asphalt or fiberglass shingles.
Metal, narrow standing seam or 5-V panels, metal finish or painted.
Slate or synthetic slate.

CLADDING

Cladding should be consistent on all facades of primary mass. Exceptions include: secondary wings, bays and garages.

SIDING

Smooth, horizontal bevel or lap wood or fiber-cement siding, 4 to 8 inches exposure, miter-cut corners or with $\frac{5}{4}$ by 6 inch corner boards.
Wood clad houses have 8 to 10 inch wide skirt boards.

STONE

Stone: Horizontal proportioned stone larger than the human hand - laid in a coursed horizontal pattern, dry stack (minimal mortar visible).
No thin veneers.

STUCCO

Light sand finish.



Partial Elevation, 2 Story

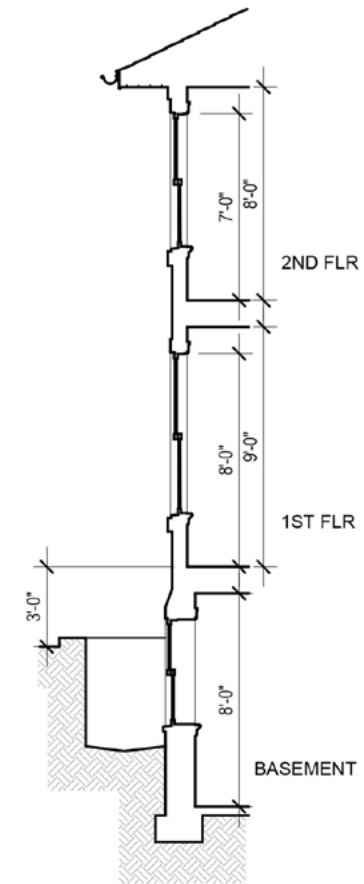

Section, 2 Story

PRAIRIE – EAVES & DORMERS

EAVES

Deep eaves are a dominant characteristic.
Eaves are typically closed and are minimum 2'-0".

TRIM

Wood, composite, cellular PVC, fiber-cement, or polymer millwork acceptable.

DORMERS

Hip pitch same as house.
No wall surface either side of dormer window. Window casing acts as cornerboard.

EAVES

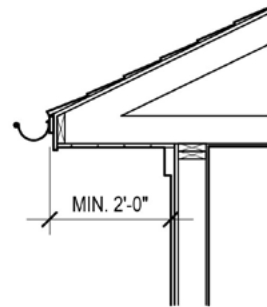

Section, Closed Eave

DORMERS



Hip Dormer

PRAIRIE – WINDOWS & DOORS

WINDOWS

Standard Windows

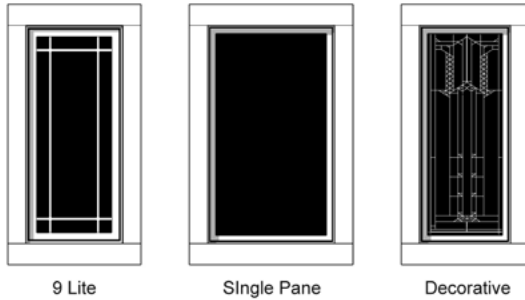

Window Assemblies

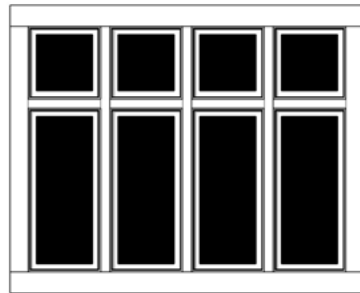

Casement windows are most common to this style.

Windows proportions range in aspect ratio from 2:5 to 3:5, typically. Use the same window lite pattern and proportion throughout except in special locations such as gables, dormers, or window bays.

Windows are typically always ganged together. Combine windows using a minimum 3" wide trim between windows. Use the same material as jamb and header.

First-floor windows are typically taller than second and third floor windows.

WINDOW AND DOOR TRIM

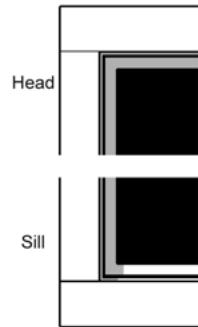

6" flat trim (square joint) and 7" tall header with 7" sill

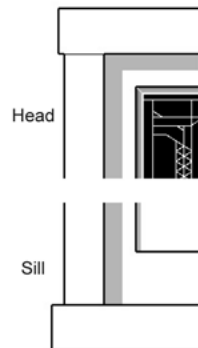

6" flat trim and 7" tall header and sill that extend 1" beyond trim

DOORS

Standard Doors

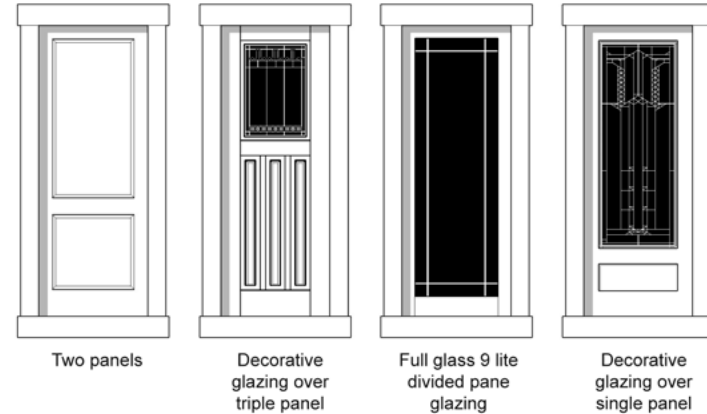

Door Assemblies



Full glass 9 lite door with single pane sidelights and transom

Double doors; each with 3/4 lite decorative glazing over single panel

Standard door heights are typically 6'-8", 7'-0", or 8'-0" tall for this style.

Integration of glass is recommended for front entry doors, along with the use of sidelights and/or transom windows.

Use the decorative lite pattern selectively. Align door and window heads, except in special locations.

Recess windows and doors into wall for deep shadow effect.

PRAIRIE – PRECEDENTS & POSSIBILITIES



TERRAINE PATTERN BOOK

4.0

DESIGN REVIEW PROCESS

This section provides a guide for the design review process for the Terraine community. The process involves a series of meetings between Homebuilders, Owners, Contractors and/or design professionals as applicable. It begins with an initial meeting and concludes with the completion of complete streetscapes, homes and improvements consistent with these Terraine Guidelines. Terraine may also provide specific special address scripting requirements for key areas of the

Terraine Community Plan (Refer to Neighborhood Guidelines for additional requirements).

Along the way are a series of meetings, or check points, designed to ensure a smooth and efficient review of building and site designs to create thoughtfully considered neighborhoods in conjunction with quality and functional designs. The DRC is committed to assisting Homebuilders and Owners through the design review process.

4.1 PROJECT TYPES TO BE REVIEWED

DRC review and approval is to be obtained for all project types listed below:

- **New Construction** – Construction of any new, freestanding structures, whether a single Home, a series of multiple homes, and/or Accessory Building or landscape structures.
- **Alterations, additions or rehabilitation of an existing structure** – Any new construction or rehabilitation to an existing building or landscape structure that alters the original Massing, exterior finishes, window placement, roof design, exterior lighting, interior lighting visible from off-site and/or other significant design elements.
- **Major site and/or landscape Improvements** – Any major Improvements or changes to Improvements, including, but not limited to, grading (for any excavation and/or fill involving more than 50 cubic yards of dirt), planting and re-vegetation plans, tree removal, irrigation, driveways, fencing and/or drainage, that alter an existing landscape.

The DRC evaluates all development proposals on the basis of the Guidelines. Some of the Guidelines are written as broad standards and the interpretation of these standards is left up to the discretion of the DRC.

4.2 DESIGN REVIEW PROCESS OVERVIEW

Terraine design and construction review process, unless otherwise noted takes place in five steps:

1. **Initial Meeting**
2. **Schematic Design Review**
3. **Design Development Review**
4. **Construction Documents**
5. **Construction Monitoring**

Any Improvement as described above requires submission of plans, specifications and any required application fee. The Homebuilders and Owners are to retain competent assistance from an Architect, Landscape Architect, Structural Engineer, Civil Engineer, Contractor and any other Consultants as necessary. Homebuilders, Owners and Consultants are to carefully review the Master Declaration and the Guidelines prior to commencing with the design review process.

Having secured final design approval from the DRC, the Homebuilder or Owner is to also meet all submittal and approval requirements of the City of West Jordan and any other requisite authorities.

Homebuilders and Owners are to commence construction within one year of final design approval from the DRC. If the Builder/Owner fails to begin construction within this time period, the approval may be revoked by the DRC. All landscape Improvements are to be installed within one summer season of occupancy. Written approval from the DRC is required prior to any time extensions for construction and/or landscape installation.

4.3 DESIGN REVIEW PROCESS – MINOR IMPROVEMENTS

Minor Improvements (including, but not limited to, the construction of, installation of, or addition to landscaping, fences, walls, and/or enclosure structures), which are being completed independent of any major Improvements as listed in Section 4.1 above, do not need to proceed through all five steps of the general design review process. Minor Improvements may often be submitted as part of a two-step review process:

1. **Final Design Review**
2. **Construction Monitoring**
3. **Final Observation**

Specific submission requirements and any application fees will be determined on a case-by-case basis as required by the nature of the Improvement. Homebuilders, Owners and/or Consultants are to contact the DRC to verify whether an Improvement qualifies for the abbreviated design review process. Upon receipt of permission to proceed with an abbreviated process, the Owner and/or Consultant will obtain a list of specific submission requirements from the DRC.

4.4 ACTIONS AND APPROVALS

The DRC's action on matters is to be by a majority vote of the DRC. The DRC will keep and maintain a record of all actions taken by it.

If an Applicant disagrees with the DRC's written conclusions from a meeting or application, the Applicant may appeal the decision in accordance with the procedures set forth in the Master Declaration.

The powers of the DRC relating to design review will be in addition to all design review requirements imposed by the City of West Jordan.

4.5 DESIGN PROFESSIONALS

The design team should be comprised of the following Consultants as applicable for each Project:

- **Architect**
- **Landscape Architect**
- **Structural and Civil Engineers**
- **Homebuilder**
- **Additional professional Consultants as required**

Prior to the scheduling the Initial Conference, the following actions are to be taken by the Design Team:

- The Homebuilder, Architect and/or Landscape Architect are to review all applicable Design Guidelines documents for Terraine.
- The Homebuilder, Architect and/or Landscape Architect are to review the zoning and building regulations for the City of West Jordan.

4.6 INITIAL CONFERENCE

Prior to preparing any drawings for proposed Improvements, Homebuilders, Owners, their Architect and Landscape Architect are to meet with a representative of the DRC to discuss proposed plan and/or segment (particular street addresses) assignments to resolve any questions regarding building and design requirements.

This meeting will initiate the review and approval process. The parameters and directives identified at each Initial Conference remain valid for one year. If the submittal of a preliminary design does not occur within twelve months of the Initial Conference, a supplementary Initial Conference may be required to review any changes in neighborhood design, site conditions and/or revisions to the Design Guidelines.

The following information and materials, as appropriate, are required at the Initial Conference:

1. **Terraine Community Plan** – as provided by Terraine
2. **Terraine Architectural + Landscape Pattern Book**
3. **Neighborhood Pattern Book** (as applicable)

Additional information may be requested by the DRC, as necessary to describe the project. The Initial Conference may be scheduled by contacting the DRC at least 14 working days prior to the desired meeting date.

4.7 SCHEMATIC DESIGN REVIEW

The Schematic Design Review is to be scheduled within eight months of the Initial Conference. During the Schematic Design Review, the DRC will review schematic plans (see Section 4.7.1) to ensure that:

- All structures are sited to step with the topography, blend into the landscape and minimize grading and site impact.
- The transition between buildings and the surrounding environment accomplishes the intent a of the Guidelines.
- Building massing, roofs, materials and other site and architectural Improvements are consistent with the Design Guidelines and create a comprehensive streetscape and neighborhood design.

4.7.1 Schematic Design Review Submission Materials

The Schematic Design Review package is to adequately convey (as appropriate and applicable) existing site conditions, constraints, building orientation and design, vehicular and pedestrian access, the proposed use of exterior materials and the conceptual landscape design. All plans are to be prepared by design professionals. Applications are to be submitted a minimum of 14 working days prior to the desired meeting date. A Schematic design submittal will not be considered complete until the DRC has received the following materials:

1. **Application Form and Fee** – a completed application form as obtained from the DRC office as applicable.
2. **Surveys** – (1" = 20'-0" minimum scale) a survey prepared by a licensed surveyor indicating property boundaries, lot areas, all easements of record, utility locations, existing topography, rock outcroppings and any significant drainages, as applicable.
3. **Site Plan** – (1" = 20'-0" minimum scale) showing the location of each Homesite Envelope, proposed grading, conceptual drainage, building footprints, proposed finished floor elevations, garage and guest parking, driveway access, terraces, patios, and special terrain features to be preserved. All Plans are to note what Terraine Architectural Style is being used.
4. **Floor Plan Options** – (1/8" = 1'-0" minimum scale) At least 3 floor plan options for all proposed structures (as applicable), including proposed uses; wall, door and window locations; overall dimensions; finished floor elevations; and total square footage of all floors; roof pitches; and the location of chimneys and other roof projections. Total square footage and conceptual budgets are to also be included.
5. **Roof Plans** – (1/8" = 1'-0" minimum scale) for all proposed structures, including roof pitches, materials and the location of chimneys, satellites, solar panels and other roof projections.
6. **Exterior Elevations** – (1/8" = 1'-0" minimum scale) at least 3 sets of 4 elevations, showing both existing and proposed grade lines, plate heights, ridge heights, roof pitch, roof projections and a preliminary indication of all exterior materials and colors, including walk out basement condition if applicable.
7. **Conceptual Landscape Plan** – (1" = 10'-0" minimum scale) a conceptual plan showing irrigated areas, conceptual drainage courses, planting areas, a preliminary plant list, extent of lawns, areas to be revegetated, the fire safety zone, water features, patios, decks, courtyards, schematic utility layout, service areas and any other significant design elements.

The DRC reserves the right to amend Schematic Design Review submission requirements on a case-by-case basis as required by conditions and considerations particular to each Neighborhood, Homesite and/or Improvement. Once a complete submission has been received, the DRC will notify the Applicant in writing of its receipt and schedule the Homesite for the next available Schematic Design Review meeting.

4.7.2 Schematic Design Review Meeting

Upon receipt of a complete submission, the Schematic Design Review will be scheduled for the next available meeting. The DRC will review and comment on the application at the meeting and will subsequently provide the Owner with the conclusions of the meeting in writing within 14 days of the meeting.

Corrected materials are to be provided to the DRC within 30 days of issuance of the meeting's conclusion per the Design Development Review step (section 4.8).

4.8 DESIGN DEVELOPMENT REVIEW

The Design Development Review is to be scheduled within eight months of Schematic Design Review approval. During the Design Development Review, the DRC will review plan submissions to ensure that:

- Any critical issues discussed at the Schematic Design Review have been addressed and resolved.
- Building details, materials and colors are appropriate for the site and comply with the Design Guidelines.
- All other Improvements are designed in accordance with the Design Guidelines.

4.8.1 Design Development Review Submission Materials

The Design Development Review package is to adequately convey (as appropriate and applicable) existing site conditions, constraints, building orientation and proposed Improvements. All plans are to be prepared by design professionals and put into CAD formats. Applications are to be submitted a minimum of 14 working days prior to the desired meeting date. A Design Development submittal will not be considered complete until the DRC has received the following materials:

1. **Application Form** – a completed application form as obtained from the DRC office as applicable.
2. **Site Plan** – (1" = 20'-0" minimum scale) showing location of each Homesite Envelope, existing topography, proposed grading, all buildings, finished floor elevations, sidewalks, streets, driveways, address markers, culverts, drainage features, parking areas, outdoor areas and storage areas, utility sources and connections, site walls and any other Improvements, as appropriate.
3. **Grading, Drainage and Erosion Control Plans** – (1" = 20'-0" minimum scale) showing existing and proposed grades, all drainage structures and/or other drainage design solutions, and cut and fill calculations. Plans are to also indicate the size of stockpiles, where they are to be located on the Construction Site and the length of time they will remain. The extent and location of sediment fencing and measures taken to control erosion during grading and construction are also to be indicated.
4. **Landscape Plans** – (1" = 20'-0" minimum scale) including irrigation plans with locations of main irrigation lines, areas of automatic irrigation, type of controls and heads; proposed plant materials, sizes, and locations; vegetation to be removed; areas of planting, water features, patios, decks, courtyards, utility layout, service areas and any other significant design elements; top and bottom of wall elevations; and material specifications.
5. **Lighting Plan** – (1/8" = 1'-0" minimum scale) including locations of all exterior architectural and landscape light fixtures. Cut sheets are to be submitted for all proposed fixtures and bulb types, including wattage specifications.
6. **Floor Plans** – (1/8" = 1'-0" minimum scale) for all proposed structures, including proposed uses; wall, door and window locations; overall dimensions; finished floor elevations and the total square footage of all floors.
7. **Roof Plans** – (1/8" = 1'-0" minimum scale) for all proposed structures, including roof pitches, materials and the location of chimneys, satellites, solar panels and other roof projections.
8. **Building Sections** – (1/8" = 1'-0" minimum scale) indicating existing and proposed grades and finished floor, ceiling plate and ridgeline elevations.
9. **Exterior Elevations** – (1/8" = 1'-0" minimum scale) showing both existing and proposed grade lines, ridge heights, roof pitch, roof projections (chimneys, vents satellites, solar panels) exterior materials and colors.
10. **Neighborhood Elevation, or Block Face Layout (1"=20'-0" minimum scale)**– One elevation illustrating the sequence of home types along a block to ensure no repetitive facades, color schemes and/or home types.
11. **Details** – (1/4" = 1'-0" minimum scale) details of doors, porches, windows, rafter tails, rails, wall openings, retaining walls, address marker identification sign (if proposed) and other architectural elements that establish and further describe the character and overall style of the house.

- 12. Sample Board** – samples of all exterior materials and colors, and indication of how homes and exterior materials are sequenced along a block to ensure no repetitive elevations, color schemes on a given block (as applicable) including:
- » *Roofs*
 - » *Wall siding - Exterior trim*
 - » *Windows - Doors*
 - » *Fences - Railings*
 - » *Paving*
- 13. Construction Schedule** – include start and completion dates for both construction and landscape installation.
- 14. Construction Management Plan** – showing the area in which all Construction activities will be confined, and how the site will be managed and protected. The Construction Management Plan is to indicate the following:
- a. Area of Disturbance*
 - b. Type, size and color of the construction trailer or portable office*
 - c. Vehicular access route*
 - d. Location and size of the construction storage area*
 - e. Parking areas (including maximum number of vehicular parking spaces)*
 - f. Locations of the chemical toilet, dumpster and debris storage, wash-off areas and fire fighting equipment;*
 - g. Areas of utility trenching;*
 - h. Limit of excavation, drainage patterns and erosion control measures in compliance with Best Management Practices, and*

The DRC reserves the right to amend Design Development Review submission requirements on a case-by-case basis as required by conditions and considerations particular to each Project, Homesite and/or Improvement.

4.8.2 Design Development Review Submission Meeting

Upon receipt of a complete submission, the Design Development Review will be scheduled for the next available meeting. The DRC will review and comment on the application at the meeting and will subsequently provide the Applicant(s) with the conclusions of the meeting in writing within 14 days of the meeting.

Corrected materials are to be provided to the DRC within 30 days of issuance of the meeting's conclusion.

Design Development approval must be obtained from the DRC prior to submitting to the City of West Jordan for all applicable building permits. Design Development approval is valid for 8 months from the date of notification. If final design approval expires, all approvals are revoked and Applicants shall repeat the Design Development Review unless waived by the DRC.

4.9 CITY OF WEST JORDAN APPROVAL

The Owner is to apply for all applicable building permits from the City of West Jordan. Any adjustments to DRC-approved plans required by the City are to be submitted to the DRC for review and approval prior to commencing construction. The issuance of any approvals by the DRC does not imply corresponding compliance with the legally required demands of other agencies.

No materials, tools, temporary offices or portable toilets, excavation or construction equipment or similar materials or equipment may be delivered to the site prior to the issuance of all building Permit(s).

4.10 CONSTRUCTION DOCUMENT PREPARATION

A full building set of construction documents is to be prepared in compliance with Design Development approvals and submitted to the DRC to ensure that all designs are consistent with approvals.

4.11 SUBSEQUENT CHANGES

Subsequent construction, landscaping or other changes in the intended Improvements that differ from approved final design development approvals, sample boards are to be submitted to the DRC for review and approval prior to making changes.

4.12 CONSTRUCTION REVIEW OBSERVATIONS

During construction, the DRC will check construction to ensure compliance with approved final design documents. These observations may be obtained by the DRC. If changes or alterations have been found that have not been approved, the DRC will issue a Notice to Comply.

4.13 NOTICE TO COMPLY

When as a result of construction monitoring/observations the DRC finds changes and/or alterations that have not been approved or a non-compliance with the Construction Guidelines (see Chapter 7), the DRC will issue a Notice to Comply within three (3) working days of the observation. The DRC will describe the specific instances of non-compliance and will require the Owner to comply or resolve the discrepancies.

The DRC reserves the right to issue a “stop work” order in cases of severe non-compliance.

4.14 COMPLIANCE CERTIFICATE

Construction is to be completed within 18 months of commencement. Upon completion of construction, the Homebuilder, Owner and/or Contractor are to give written notice to the DRC requesting a Final Observation. The DRC will make a final inspection of the property within 30 days of notification. If construction is complete and in compliance with DRC-approved plans and the Design Guidelines, the DRC will issue a Compliance Certificate (subject to completion of landscape installation) within this same 30-day period. If it is found that the work was not done in compliance with the approved final design documents, the DRC will issue a Notice to Comply, specifying the particulars of noncompliance, within 7 working days of the observation. All non-complying Improvements are to be promptly corrected within 30 days of the observation.

4.15 RIGHT OF WAIVER

The DRC has the authority to approve deviations from portions of the Guidelines that are not mandated by the City of West Jordan. Any request to deviate from these Guidelines will be evaluated at the sole discretion of the DRC. Prior to the DRC approving any deviation from the Design Guidelines, it must be demonstrated that the proposal is consistent with the overall objectives of the Guidelines and will not adversely affect adjacent properties or Terraine as a whole.

4.16 NON-WAIVER, INADVERTENT PRECEDENTS

The DRC's approval of any plans, drawings or specifications for any work done or proposed shall not be deemed to constitute a waiver of any right to withhold approval of any similar plan, drawing or specification subsequently or additionally submitted for approval. For example, the DRC may disapprove an item shown in the Design Development submittal even though it may have been evident and could have been, but was not, disapproved at the Schematic Design Review. Failure to enforce any of these Design Guidelines shall not constitute a waiver of same. An oversight by the DRC of non-compliance at anytime during the review process, construction process or during its final observation does not relieve the Homebuilder or Owner from compliance with these Guidelines and all other applicable codes, ordinances and laws.

4.17 DESIGN REVIEW SCHEDULE

The DRC will make every reasonable effort to comply with the time schedule for design review. However, the DRC will not be liable for delays that are caused by circumstances beyond its control. The DRC will provide design review according to the following schedule:

1. Initial Conference

- » *Meeting requested at least 14 working days prior to the desired meeting date.*

2. Schematic Design Review

- » *Application documents to be submitted at least 14 working days prior to the desired meeting date and within eight months of the Initial Conference.*
- » *Written comments provided to Owner within 14 days of meeting.*

3. Design Development Review

- » *Application documents to be submitted 14 working days prior to the desired meeting date and within eight months of schematic design approval.*
- » *Written comments provided to Owner within 14 days of meeting.*

4. Minor Improvement

- » *Application documents to be submitted a minimum of 14 working days prior to the next scheduled DRC meeting*
- » *Written comments from the DRC meeting provided to Owner within 30 days of receipt of submission.*

5. Building Permits

- » *Owner applies to the City of West Jordan for all applicable building and use permits.*

6. Final Observations

- » *Final Construction Observation within 30 days of receipt of written request =.*

4.18 APPLICATION FEES

In order to defray the expense of reviewing plans, monitoring construction and related data, and to compensate consulting Architects, Landscape Architects and other professionals, the DRC has established a total design review fee for the Design Review Process payable upon submittal of the initial project application. Fees for resubmission may also be required by the DRC on a case-by-case basis. Application fees may be amended from time to time, as needed. A current fee schedule may be obtained from the DRC office.

To assure the construction of any Improvement within Terraine occurs in a safe and timely manner without damaging the natural landscape and while minimizing disturbance to residents or guests, these Guidelines will be enforced during all Construction Activities. Homebuilders and/or Owners shall be responsible for violations of the Design Guidelines (including the construction regulations contained herein) by any Contractor, subcontractor, agent, or employee performing any activities on behalf of the Homebuilder or Owner within Terraine, whether located on the Homesite or elsewhere within the community.

APPENDIX A

DEFINITIONS

ACCESSORY DWELLING UNIT

See City of West Jordan, Planned Community Hillside Zone (PCH) ordinance No. 20-19.

APPLICANT

A Homebuilder, Owner and/or Owner's Consultant that is applying for approval on the new construction, renovation, alteration, addition and/or any other Improvement to any building and/or Homesite.

ARCHITECT

A person licensed to practice architecture in the State of Utah.

AREA OF DISTURBANCE

The area surrounding Construction Activities that is impacted by such construction.

BOARD OF DIRECTORS (BOARD)

See definition contained in the Master Declaration.

BUILDABLE AREA

See City of West Jordan, Planned Community Hillside Zone (PCH) ordinance No. 20-19.

BUILDING HEIGHT

See City of West Jordan, Planned Community Hillside Zone (PCH) ordinance No. 20-19.

COMPLIANCE CERTIFICATE

Written notice given by the DRC upon Final Observation approval.

COMPLIANCE DEPOSIT

A deposit paid by the Homebuilder, Owner or Contractor to the DRC prior to commencing any Construction Activity.

CONSTRUCTION ACTIVITY

Any site disturbance, construction, addition or alteration of any building, landscaping or any other Improvement on any Construction Site.

CONSTRUCTION AREA

The area in which all Construction Activity, including Construction Vehicle parking, is confined on a particular Homesite.

CONSTRUCTION SITE

A site upon which Construction Activity takes place.

CONSTRUCTION VEHICLES

Any car truck, tractor, trailer or other vehicle used to perform any part of a Construction Activity or to transport equipment, supplies or workers to a Construction Site.

CONSULTANT

A person retained by an Owner to provide professional advice or services.

CONTRACTOR

A person or entity retained by an Owner for the purpose of constructing any Improvement within Terraine.

CRAFTSMAN

The craftsman architectural style is typified by its attention to detail, the use of natural building materials and generally low horizontal building forms.

DECLARANT

See definition contained in the Master Declaration.

DESIGN GUIDELINES (GUIDELINES)

The standards, review procedures and construction regulations adopted and enforced by the DRC as set forth in this document and as amended from time to time by the DRC.

DESIGN REVIEW COMMITTEE (DRC)

See definition contained in the Master Declaration.

EXCAVATION

The digging and removal of earth from its natural position, or the cavity resulting from such removal.

FILL

The amount of material used to increase an existing grade.

GREEN DESIGN, (GREEN), (SUSTAINABLE DESIGN)

The implementation of environmentally sensitive and resource conserving techniques into the design and construction of buildings and landscape. Green Design is intended to create Residences that are integrated with the local landscape and climate and create a healthier living environment for the building's residents and neighbors.

IMPROVEMENT

The definition of Improvement throughout this document is consistent with that provided in the Master Declaration as applied to individual Homesites at Terraine.

LANDSCAPE ARCHITECT

A person licensed to practice landscape architecture in the State of Utah.

LANDSCAPE ENHANCEMENT ZONE

An area where specific planting is to occur in order to restore or protect a Homesite's ecology or to provide buffering for the Homesite.

HOMESITE

See definition for "Lot" contained within the Master Declaration.

MANAGED GRASSLANDS

The common areas managed by the community, consisting primarily of lands needed to service the community, such as road right-of-way's.

MASSING

The overall size, volume, spread, expression and articulation of building forms, including the main house, Accessory Structures, covered terraces and other roofed areas, as they relate to the topography and landscape of each particular site. A building's compliance with the maximum Buildable Area may not be sufficient to demonstrate a building has complied with all Massing requirements as described in these Guidelines.

MASTER DECLARATION

The Master Declaration of Covenants, Conditions and Restrictions for Terraine.

NOTICE TO COMPLY

Written notice issued to an Owner and/or Contractor of any changes and/or alterations not in compliance with DRC-approved plans or the Design Guidelines, which are to be corrected as requested by the DRC.

OWNER

See definition contained in the Master Declaration.

PARCEL

See definition contained in the Master Declaration.

PRESERVE LANDS

These lands provide a contiguous grassland landscape and habitat zone. Comprised of over 169 acres, this area is a regional resource for ongoing study, recreation, education and preservation efforts.

PRIVATE AREA

That portion of the Homesite that includes buildings, walls and outdoor private spaces. The buildings within the Private Area are to conform to the Maximum Building Height and Buildable Area requirements.

RESIDENCE

See definition contained in the Master Declaration.

STORY

See City of West Jordan, Planned Community Hillside Zone (PCH) ordinance No. 20-19.

APPENDIX B

APPROVED PLANT LIST *for* TERRAINE**TREES - DECIDUOUS**

- » *Acer ginnala* – Amur Maple
- » *Acer grandidentatum* – Bigtooth Maple*
- » *Acer glabrum* – Rocky Mountain Maple*
- » *Acer negundo* ‘Sensation’ – Sensation Boxelder*
- » *Acer tataricum* – Tatarian Maple
- » *Catalpa speciosa* – Northern Catalpa
- » *Cercis occidentalis* – Western Redbud*
- » *Celtis occidentalis* – Hackberry
- » *Gymnocladus dioica* ‘Espresso’ – Kentucky Coffee Tree
- » *Maackia amurensis* - Maackia
- » *Prunus virginiana melanocarpa* – Common Chokecherry*
- » *Quercus gambelii* – Gambel Oak*
- » *Robinia pseudoacacia* ‘Purple Robe’ – Purple Robe Black Locust
- » *Syringa reticulata* – Tree Lilac
- » *Syringa reticulata subsp. pekinensis* - Peking Lilac
- » *Tilia tomentosa* – Silver Linden
- » *Ulmus* x ‘Frontier’ – Frontier Elm
- » x *Chitalpa tashkentensis* – Chitalpa

*Native to the Intermountain West

TREES - EVERGREEN

- » *Juniperus scopulorum* – Rocky Mountain Juniper*
- » *Pinus aristata* – Bristlecone Pine*
- » *Pinus edulis* – Pinyon Pine*
- » *Pinus heldreichii* – Bosnian Pine

SHRUBS

- » *Amelanchier alnifolia* – Saskatoon Serviceberry*
- » *Amelanchier utahensis* – Utah Serviceberry*
- » *Arctostaphylos coloradoensis* – Panchito Manzanita*
- » *Arctostaphylos patula* – Greenleaf Manzanita*
- » *Artemisia cana* – Silver Sagebrush*
- » *Artemisia filifolia* – Sand Sagebrush*
- » *Artemisia frigida* – Fringed Sagebrush*
- » *Artemisia ludoviciana* – Prairie Sage*
- » *Artemisia nova* – Black Sagebrush*
- » *Artemisia tridentata* – Big Sagebrush*
- » *Atriplex* sp. – Saltbush*
- » *Caryopteris x clandonensis* – Blue Mist Shrub
- » *Cercocarpus ledifolius* – Curl Leaf Mountain Mahogany*
- » *Cercocarpus montanus* – Mountain Mahogany*
- » *Chamaebatiaria millefolium* – Fernbush*
- » *Cotinus coggygri* – Smoke Bush

- » *Cowania mexicana* – Mexican Cliffrose*
- » *Ephedra viridis* – Mormon Tea*
- » *Ericameria nauseosa* – Rubber Rabbitbrush*
- » *Euonymus nanus turkestanicus* – Spindle Tree
- » *Forestiera neomexicana* – New Mexico Privet*
- » *Hibiscus syriacus* – Rose of Sharon
- » *Mahonia aquifolium* – Oregon Grape*
- » *Paxistima myrsinites* – Mountain Lover*
- » *Philadelphus lewisii* – Mock Orange*
- » *Physocarpus malvaceus* – Mallow-leaf Ninebark*
- » *Physocarpus opulifolius* – Ninebark*
- » *Pinus mugo* – Mugo Pine
- » *Prunus besseyi* – Wester Sand Cherry*
- » *Prunus laurocerasus* – Cherry Laurel
- » *Purshia* sp. – Cliffrose*
- » *Ribes aureum* – Golden Currant*
- » *Rhus glabra* – Smooth Sumac*
- » *Rhus trilobata* – Three-Leaf Sumac*
- » *Rosa woodsia* – Woods Rose*
- » *Sambucus canadensis* – Common Elderberry*
- » *Shepherdia* sp. – Buffaloberry*
- » *Symphoricarpos albus* – Common Snowberry*

For more information on the plants in this list, the following websites and books are valuable resources:

1. *USU Extension Ornamental Grasses in the Landscape Guide* - online
2. *The American Meadow Garden* by John Greenlee - book
3. *Planting, A New Perspective* by Piet Oudolf and Noel Kingsbury - book
4. *Planting in a Post-Wild World* by Thomas Rainer and Claudia West - book
5. *Conservation Water Park - West Jordan* - website
6. *USU Water-wise Plants for Utah Landscapes Fact Sheet* - online
7. *Gardening for the Birds* by George Adams - book

PERENNIALS

- » *Achillea sp.* – Yarrow*
- » *Agastache cana* – Texas Hummingbird Mint*
- » *Agastache rupestris* – Sunset Mint*
- » *Aquilegia sp.* – Columbine*
- » *Alcea rosea* – Hollyhock
- » *Allium sp.* – Allium
- » *Amsonia jonesii* – Bluestar*
- » *Anaphalis margaritacea* – Western Pearly Everlasting*
- » *Aster x frikartii 'Monch'* – Monch Aster
- » *Aurinia saxatilis* – Basket of Gold
- » *Berlandiera lyrata* – Chocolate Flower
- » *Callirhoe involucrata* – Purple Poppy-mallow*
- » *Centranthus ruber* – Red Valerian
- » *Coreopsis sp.* – Tickseed*
- » *Echinacea purpurea* – Coneflower*
- » *Epilobium sp.* – Fire Chalice*
- » *Erigeron speciosus* – Azure Fairy*
- » *Eriogonum sp.* – Buckwheat*
- » *Gaillardia aristata* – Blanket Flower*
- » *Geranium sp.* – Hardy Geranium*
- » *Helenium sp.* – Sneezeweed*
- » *Helianthus sp.* – Sunflower*
- » *Hesperaloe parviflora* – Red Yucca*
- » *Lavandula sp.* – Lavender
- » *Linum lewisii* – Western Blue Flax*
- » *Lupinus sp.* – Lupine*
- » *Mirabilis multiflora and cvs.* – Desert Four O-Clock*
- » *Nepeta sp.* – Catmint
- » *Oenothera sp.* – Evening Primrose*

- » *Penstemon sp.* – Beardtongue*
- » *Perovskia atriplicifolia* – Russian Sage
- » *Phlox sp.* – Phlox
- » *Ratibida columnifera* – Prairie Coneflower*
- » *Sedum sp.* – Upright Stonecrop
- » *Solidago multiradiata* – Rocky Mountain Goldenrod*
- » *Sphaeralcea sp.* – Globemallow*
- » *Stanleya pinnata* – Prince's Plume*
- » *Veronica pectinata* – Blue Woolly Speedwell
- » *Yucca sp.* – Yucca*
- » *Zauschneria sp.* – Fire Chalice*
- » *Zinnia grandiflora* – Plains Zinnia*

ORNAMENTAL GRASSES

- » *Achnatherium hymenoides* – Indian Ricegrass*
- » *Andropogon gerardii* – Big Bluestem*
- » *Aristida purpurea* – Threeween Grass*
- » *Bouteloua gracilis* – Blue Grama*
- » *Deschampsia caespitosa* – Tufted Hair Grass*
- » *Elymus sp.* – Wildrye*
- » *Festuca idahoensis* – Idaho Fescue*
- » *Leymus sp.* – Wildrye
- » *Miscanthus sinensis* – Maiden Grass
- » *Nassella tenuissima* – Mexican Feathergrass*
- » *Panicum virgatum* – Switchgrass*
- » *Poa secunda var. juncifolia* – Blue Grass*
- » *Schizachyrium scoparium* – Little Bluestem*
- » *Sorghastrum nutans* – Indiangrass*
- » *Sporobolus airoides* – Alkali Sacaton*
- » *Sporobolus heterolepis* – Prairie Dropseed

GROUNDCOVERS

- » *Antennaria sp.* – Pussytoes
- » *Archtoostaphylos uvi-ursi* – Kinnikinnick
- » *Callirhoe involucrata* – Prairie Winecups
- » *Cerastium tomentosum* – Snow in Summer
- » *Delosperma sp.* – Ice Plant
- » *Euonymus fortunei 'Colorata'* – Purpleleaf Wintercreeper
- » *Juniperus horizontalis* – Creeping Juniper
- » *Mahonia repens* – Creeping Oregon Grape
- » *Rhus aromatica 'Gro-Low'* – Gro-Low Fragrant Sumac*
- » *Sedum sp.* – Stonecrop
- » *Sempervivum sp.* – Hen and Chicks
- » *Thymus sp.* – Thyme

TURF ALTERNATIVES

Note: The turf alternatives listed here are not appropriate for high foot traffic or shaded areas.

- » *Achillea sp.* – Yarrow* mown as lawn
- » BioMeadow Sod
- » *Bouteloua curtipendula* – Sideoats Grama*
- » *Bouteloua gracilis* – Blue Grama Grass*
- » *Buchloe dactyloides 'Legacy'* – Legacy Buffalo Grass*
- » Desert Green Sod

VINES

- » *Lonicera sp.* – Native Honeysuckle*
- » *Parthenocissus quinquefolia* – Virginia Creeper

BULBS

- » *Crocus sp.* – Crocus
- » *Iris missouriensis* – Rocky Mountain Iris*
- » *Muscari sp.* – Grape Hyacinth

SHRUBS

Botanical Name	Common Name	Native	Height/ Spread	Sun/ Shade	Flower Color / Seasonal Interest						Foliage; Fall Color (FC) or Evergreen (EV)
					Spring	Early Summer	Mid- Summer	Late Summer	Autumn	Winter	
<i>Amelanchier alnifolia</i> and <i>A. utahensis</i>	Saskatoon Serviceberry and Utah Serviceberry	X	10-12' / 8-10'	Sun-Pt		White Flowers		Berries			FC
<i>Arctostaphylos x coloradoensis</i>	Panchita Manzanita	X	1-2' / 3-5'	Sun-Pt	Flowers						EV
<i>Artemisia frigida</i> and others	Native Sagebrushes	X	Varies	Sun							EV
<i>Caryopteris x claudonsis</i>	Blue Mist Shrub		2-3' / 2'	Sun				Fragrant Flowers			
<i>Cercocarpus ledifolius</i>	Curl-leaf Mountain Mahogany	X	5-15' / 5-15'	Pt Shade							EV
<i>Chamaebatiaria millefolium</i>	Fernbush	X	4-6' / 4-6'	Sun		White Flowers					EV
<i>Cowania (Purshia) mexicana</i>	Mexican Cliffrose	X	4-6' / 4-6'	Sun	Fragrant Flowers						EV
<i>Ephedra viridis</i>	Mormon Tea	X	2-4' / 2-4'	Sun							EV
<i>Ericameria nauseosa</i>	Rubber Rabbitbrush	X	4-6' / 4-6'	Sun				Fragrant Flowers	Flowers persist		
<i>Forestiera neomexicana</i>	New Mexico Privet	X	10-12' / 10'	Sun-Pt				Berries			FC
<i>Mahonia aquifolium</i>	Oregon Grape	X	3' / 5'	Shade	Flowers		Berries				EV
<i>Paxistima myrsinites</i>	Mountain Lover	X	1-2' / 4-5'	Shade	New Foliage	Flowers					EV
<i>Philadelphus lewisii</i>	Mock Orange	X	3' / 3'	Sun-Pt			Fragrant Flowers				FC
<i>Physocarpus opulifolius</i>	Ninebark		4-10' / 4-10'	Sun-Pt		White Flowers	Lime Green Leaves	Berries			FC
<i>Prunus besseyi</i>	Western Sandcherry	X	6' / 6'	Sun-Pt	Fragrant Flowers		Large Berries				FC
<i>Ribes aureum</i>	Golden Currant	X	5' / 5'	Sun-Pt	Fragrant Flowers			Edible Berries			FC
<i>Rhus trilobata</i>	Three-leaf Sumac	X	4-6' / 10'	Sun-Pt				Berries			FC
<i>Rosa woodsia</i>	Woods Rose	X	2-5' / 5'	Sun- Shade		Flowers					
<i>Shepherdia sp.</i>	Buffaloberry	X	6-12' / 6-10'	Sun	Flowers	Foliage		Berries			
<i>Symphoricarpos albus</i>	Common Snowberry	X	3-5' / 3-5'	Pt Shade			Flowers	Berries			

Note: species included in this chart are only a selection - See Approved Plant List for full list of approved shrubs.

GRASSES

Botanical Name	Common Name	Native	Height/ Spread	Sun/ Shade	Flower Color / Seasonal Interest						Foliage Color	
					Spring	Early Summer	Mid-Summer	Late Summer	Autumn	Winter		
<i>Achnatherum (Oryzopsis) hymenoids</i>	Indian Ricegrass	X	1-2' / 1-2'	Sun		Airy Seed heads						Blue-green
<i>Andropogon gerardii</i>	Big Bluestem, Turkey Foot	X	4-6' / 3-4'	Sun				Bloom	FC			Blue-green
<i>Aristida purpurea</i>	Purple Threawn Grass	X	2' / 1.5'	Sun	Bloom				FC			Bright Green
<i>Bouteloua gracilis</i>	Blue Grama	X	1-2' / 1-2'	Sun			Horizontal Flag Flowers		FC	Winter		Blue-green
<i>Deschampsia cespitosa</i>	Tufted Hairgrass	X	1-2' / 1-2'	Sun-Lt Shade			Feathery Panicles on Arching Stems					Dark Green
<i>Festuca idahoensis</i>	Idaho Fescue	X	6-12" / 1-2'	Sun-Lt Shade		Spikelets on stiff stalks						Grey-green or Chalky-blue
<i>Leymus sp.</i>	Wildrye	X	varies	Sun-Lt Shade								Varies
<i>Miscanthus sinensis</i>	Maiden Grass		Dwarf to Full: 3'-6' / 3'-6'	Sun				Large Plumes		Turn Silver		Green
<i>Nassella tenuissima</i>	Mexican Feathergrass	X	2-3' / 2'	Sun-Lt Shade		Wispy Seed Heads		Seed Heads go Gold				Bright Green
<i>Panicum virgatum</i>	Switch Grass	X	3-4' / 3-4'	Sun-Lt Shade			Spikelets that hover over foliage like airy clouds			Winter		Blue-green
<i>Poa secunda var. juncifolia</i>	Alkali Bluegrass	X	1-2' / 1-2'	Sun			Spikelets on stiff stalks					Blue-green
<i>Schizachyrium scoparium</i>	Little Bluestem	X	1-3' / 1'	Sun				Bloom	FC			Bright Green
<i>Sorghastrum nutans</i>	Indian Grass	X	2-4' / 2-4'	Sun		Feathery Flowerheads						Blue-green
<i>Sporobolus airoides</i>	Alkali Sacaton	X	1-2' / 1-2'	Sun			Airy Panicles of Spikelets		FC	Winter		Blue-green
<i>Sporobolus heterolepsis</i>	Prairie Dropseed	X	1-2' / 1-2'	Sun			Fragrant Wispy Blossoms		FC	Winter		Medium-green

Note: species included in this chart are only a selection - See Approved Plant List for full list of approved grasses.

PERENNIALS

Botanical Name	Common Name	Native	Height/ Spread	Sun/ Shade	Flower Color / Seasonal Interest					
					Spring	Early Summer	Mid- Summer	Late Summer	Autumn	Winter
<i>Achillea</i> sp.	Yarrow	X	1-2' / 1'	Sun	Long Flowering Period - Many Colors					Stems persist
<i>Agastache cana</i>	Texas Hummingbird Mint	X	2-3' / 1.5'	Sun	Fragrant leaves		Flowers			
<i>Alcea rosea</i>	Hollyhock		6-8' / 1-2'	Sun	Red, Pink, White, Lt. Yellow Flowers					
<i>Amsonia jonesii</i>	Bluestar	X	1' / 1'	Sun	Flowers				Fall Color	
<i>Anaphalis margaritacea</i>	Western Pearly Everlasting	X	1-3' / 1-2'	Sun-Pt	White Flowers					
<i>Aster x frikartii</i> 'Monch'	Monch Aster		1.5-3' / 1-1.5'	Sun-Pt	Purple Flowers					Stems persist
<i>Berlandiera lyrata</i>	Chocolate Flower		1-1.5' / 1-1.5'	Sun-Pt	Long Flowering Period - Fragrant					
<i>Echinacea purpurea</i>	Coneflower	X	1-3' / 1.5'	Sun-Pt	Many Colors Available					
<i>Epilobium</i> sp. (<i>Zauschneria</i> sp.)	Fire Chalice	X	1-1.5' / 1.5'	Sun-Pt	Red / Orange Tubular Flowers					
<i>Erigeron speciosus</i>	Azure Fairy	X	1-2' / 1-2'	Sun	Purple Flowers					
<i>Gaillardia aristata</i>	Blanket Flower	X	2-3' / 1-2'	Sun	Long Flowering Period - Vibrant					
<i>Helenium</i> sp.	Sneezeweed	X	2-5' / 3-5'	Sun	Long Blooming Showy Yellow Flowers					
<i>Hesperaloe parviflora</i>	Red Yucca	X	4' / 3'	Sun-Pt		Coral Flowers on Stems			Evergreen Succulent	
<i>Linum lewisii</i>	Western Blue Flax	X	2' / 1'	Sun	Flowers					
<i>Mirabilis multiflora</i>	Desert Four O-Clock	X	1-2' / 5-8'	Sun-Pt	Attractive Leaves	Magenta Flowers				
<i>Penstemon</i> sp.	Beardtongue	X	1-3' / 1-3'	Sun	Many Colors Available					
<i>Ratibida columnifera</i>	Prairie Coneflower	X	1-3' / 1-1.5'	Sun-Pt	Long Blooming Yellow / Burgundy Flowers					
<i>Zinnia grandiflora</i>	Plains Zinnia	X	4-8" / 4-12"	Sun	Dormant	Long Blooming Yellow Flowers				

Note: species included in this chart are only a selection - See Approved Plant List for full list of approved perennials.

APPENDIX C

DESIGN DOCUMENTS

The following documents are to be used in conjunction with these Guidelines for the design and construction of all Improvements on a Homesite or group of Homesites at Terraine. In addition, all Improvements shall meet any current federal, state or local applicable standards and regulations. Plans for bulk-builders and multi-family builders may be pre-approved by Declarant and also subject to an expedited review process. It is the Homebuilder's, Contractor's or Owner's responsibility to ensure that they have the most recent issues of any of these guiding documents:

- **The Terraine Architectural + Landscape Pattern Book**
- **The Terraine Community Plan**
- **Any applicable Neighborhood Pattern Book**
- **The Terraine Homesite Matrix**
- **The City of West Jordan's Planned Community Hillside Zone (PCH) Ordinance No. 21-19**
- **Master Declaration for Terraine**
- **Terraine Landscape Master Plan**

